

Gilian 5000

Air Sampling Pump

Operation Manual



SENSIDYNE
SENSIDYNE[®]

1000 112TH Circle N, Suite 100 • St. Petersburg, Florida 33716 USA
(800) 451-9444 • (727) 530-3602 • (727) 539-0550 [FAX] • www.sensidyne.com

REF 360-0103-01 (Rev N)

Gilian 5000

Air Sampling Pump

Operation Manual



REF 360-0103-01 (Rev N)
Software Version 5.0.0 or later

PROPRIETARY NOTICE

This manual was prepared exclusively for the owner of the Gilian 5000 Live Flow Air Sampling Pump. The material within this manual is proprietary information and is to be used only to understand, operate, and service the instrument. By receiving this document, the recipient agrees that neither this document nor the information disclosed within nor any part thereof shall be reproduced or transferred, physically, electronically or in any other form, or used or disclosed to others for manufacturing or for any other purpose except as specifically authorized in writing by Sensidyne, LP.

COPYRIGHT NOTICE

© 2007, © 2008 Sensidyne, LP All Rights Reserved. No part of this document may be reproduced, transmitted, transcribed, stored in a retrieval system, or translated into any language in any form by any means without the prior written permission of Sensidyne, LP.

TRADEMARK NOTICE

Sensidyne, the Sensidyne logo, Gilian, and the Gilian logo are registered trademarks of Sensidyne, LP. Gilian 5000 and the Gilian 5000 logo are trademarks of Sensidyne, LP. These trademarks are protected through use and registration in the United States. Other trademarks and service marks used in this document are the property of their respective companies and are used only for informational and explanatory purposes.

SOFTWARE LICENSE

The software installed in the Gilian 5000 pump is the property of Sensidyne, LP and shall remain the property of Sensidyne, LP in perpetuity. The software is protected by U.S. and international copyright laws and is licensed for specific use with the Gilian 5000 pump. The user may NOT reverse-engineer, disassemble, decompile, or make any attempt to discover the source code of the software. The software may NOT be translated, copied, merged or modified in any way. The user may NOT sublicense, rent, or lease any portion of the software. The right to use the software terminates automatically if any part of this license is violated.

DISCLAIMER

THE SELLER ASSUMES NO RESPONSIBILITY WHATSOEVER, TO ANY PARTY WHOSEVER, FOR ANY PROPERTY DAMAGE, PERSONAL INJURY, OR DEATH RECEIVED BY OR RESULTING FROM, IN WHOLE, OR IN PART, THE IMPROPER USE, INSTALLATION, OR STORAGE OF THIS PRODUCT BY THE USER, PERSON, FIRM, ENTITY, CORPORATION OR PARTY NOT ADHERING TO THE INSTRUCTIONS AND WARNINGS IN THIS MANUAL, OR OTHERWISE PROVIDED BY THE SELLER OR FROM NOT ADHERING TO ALL FEDERAL, STATE, AND LOCAL ENVIRONMENTAL AND OCCUPATIONAL HEALTH AND SAFETY LAWS AND REGULATIONS.

THE SELLER SHALL NOT BE LIABLE FOR DIRECT, INDIRECT, CONSEQUENTIAL, INCIDENTAL OR OTHER DAMAGES RESULTING FROM THE SALE AND USE OF ANY GOODS AND SELLERS' LIABILITY HEREUNDER SHALL BE LIMITED TO REPAIR OR REPLACEMENT OF ANY GOODS FOUND DEFECTIVE. THIS WARRANTY IS IN LIEU OF ALL OTHER WARRANTIES, EXPRESSED OR IMPLIED, INCLUDING BUT NOT LIMITED TO THE IMPLIED WARRANTIES OF MERCHANTABILITY AND FITNESS FOR USE OR FOR A PARTICULAR PURPOSE WHICH ARE EXPRESSLY DISCLAIMED.

TABLE OF CONTENTS

Preface

• Notices	2
• Warnings	4
• EU Declaration of Conformity	5

SECTION ONE: Introduction

• Components	6
--------------------	---

SECTION TWO: Set-Up

2.1 Preparation	9
2.2 Pump Start-Up	10
2.3 Setting the Flow Rate	11
2.4 Calibration	13
2.4.1 Sample Media Method Set-Up	13
2.4.2 Display Calibration Procedure	14

SECTION THREE: Program Setup

3.1 Programming	16
3.2 Program enable/disable	17
3.3 Program Edit.....	17

SECTION FOUR: Options

4.1 Option List	18
4.2 Option Settings	19

SECTION FIVE: Operation

5.1 Starting the Sample Run	21
5.2 Stopping the Sample Run	23
5.3 Locking the Keypad	24
5.4 Unlocking the Keypad.....	24
5.5 Clearing the Run Data	25
5.6 Flow Calculation	25

SECTION SIX: Maintenance

6.1 Battery Maintenance	26
6.2 Pump Filter Maintenance	27

SECTION SEVEN: Appendices

Appendix A: Troubleshooting Guide	28
Appendix B: Parts List	30
Appendix C: Specifications	31
Appendix D: Low Flow Adapter.....	33
Appendix E: Fast Charger	37
Appendix F: Factory Calibration and Service	38



WARNINGS

READ AND UNDERSTAND ALL WARNINGS AND INSTRUCTIONS BEFORE USE

Failure to read, understand, and comply with ALL accompanying literature, product labels, and warnings could result in property damage, severe personal injury, or death.

Read and understand ALL applicable environmental health and safety laws and regulations. Ensure complete compliance with ALL applicable laws and regulations before and during use of this product.

DO NOT remove, cover, or alter any label or tag on this product, its accessories, or related products.

UNDER NO CIRCUMSTANCES should this product be used except by qualified, trained, technically competent personnel.

The Gilian 5000 portable Air Sampling Pump is intended for both indoor and outdoor use when protected from splashed or windblown liquids. The unit is not waterproof so NEVER submerge the unit in water. Pump failure or faulting may result.

Pump is Intrinsically Safe when used with specified battery pack 783-0007-01. Refer to Certifications and Approvals section for approval ratings.

DO NOT operate this product should it malfunction, require repair, or have a cracked or broken case.

DO NOT repair or modify, except as specified in Operation Manual. All user controls and adjustments are made by sealed keypad on front of pump. The only user-replaceable parts are the Battery pack, Pump Filter, and optional Low Flow Adapter with filter. (See Section Six and Appendix D).

Use ONLY specified Sensidyne parts when performing maintenance procedures described in this manual. Intrinsic safety certifications become void by substitution of components, unauthorized repair or alteration. All other Service to be performed by Sensidyne Authorized Service Departments only. (See Appendix B for Parts List. See Appendix F for Service Contact Information).

This product uses rechargeable Nickel-Metal-Hydrate batteries. Always fully charge before use. DO NOT open case, charge or replace batteries in an explosive atmosphere. Use only battery pack and chargers specified in Parts List. Do not insert any foreign objects into the battery charging jack. Do not insert any foreign objects into the battery connection. Shorting the contacts will blow the protective fuse. DO NOT operate pump while charging. Caution: Both charger and battery become warm during charging.

If the equipment can come into contact with aggressive substances, it is the responsibility of the user to take suitable precautions that prevent it from being adversely affected, thus ensuring that the Intrinsic Safety protection is not compromised. Aggressive substances are acidic liquids or gases that may attack metals, or solvents that may affect polymeric materials or other solvents or corrosives. Suitable precautions are regular checks as part of routine inspections and establishing from material data sheets that chemicals known to be present do not affect material of the pump (polycarbonate, polyphenylene, epoxy).

DO NOT operate with a dirty or blocked inlet filter or kinked tubing. Pump failure or faulting may result.

If further translation is required, please contact the Sensidyne EU Authorized Representative (see Back Cover for contact information).



EU DECLARATION OF CONFORMITY

Certificate Number:
EU-Gilian 5k i 001
Issue Date: 9/18/2023

Manufacturer Information

Sensidyne, LP
1000 112th Circle North
Suite 100
St. Petersburg, FL 33716 USA

Product Information

Product Description: Portable Air Sampling Pump
Product Number: Gilian 5000 Gilian 800i Gilian 10i

This declaration as issued is the sole responsibility of Sensidyne, LP.
The designated product(s) is (are) in conformity with the essential requirements of the following European Directives and harmonized standards:

Electromagnetic Compatibility Directive (EMC) - 2014/30/EU

Complies with the following:

- EN 61326-1:2013

Certification Documents: TP72130869.100, Issued by: TÜV SÜD America, 5610 West Sligh Ave., Suite 100; Tampa, FL 33634

ATEX Directive - 2014/34/EU

Complies with the following:

- EN IEC 60079-0:2018
- EN 60079-11:2012

Certification Documents: FM07ATEX00018, Issued by: FM Approvals Europe Ltd, One Georges Quay Plaza, Dublin, Ireland D02 E440

RoHS Directive - 2011/65/EU

Complies with the following:

- BS EN IEC 63000:2018

Sean Shannon
QA/RA Manager, Sensidyne, LP

September 18, 2023

Date

SECTION ONE

Introduction

The Gilian 5000 is a high flow rate sampling pump with extremely high back pressure capabilities. It offers user programmability for easy, flexible preprogrammed sampling schedules, long battery life, Hazardous area certification for ATEX and US in all zones and gases, and fast charge capability.

This manual assumes that the pump is in the factory default state, with program and all options disabled. Enabling the program or options can cause the pump to operate in a manner different than described in the operation section of this manual. Operation with the program or options enabled is described in the applicable section. The pump can be reset to the default state by the following procedure.

The features that can vary the behavior of the system are the user program capability.

- An option of disable restart retry
- An option to enter keyboard lock when a sample starts
- An option to start a sample immediately when power is applied
- An option to disable periodic flow adjust.

To reset pump to factory initialization state:

With the pump power on, hold down the Power/Enter Key, when “OFF” appears in display press and hold “Clr” key. Clr will appear and flash. Continue holding key until the display blanks. This procedure will disable all options, disable the program and return the display calibration to the default setup.

Components

- (1) Filter Housing Assembly (Inlet Port)
- (2) Belt Clip

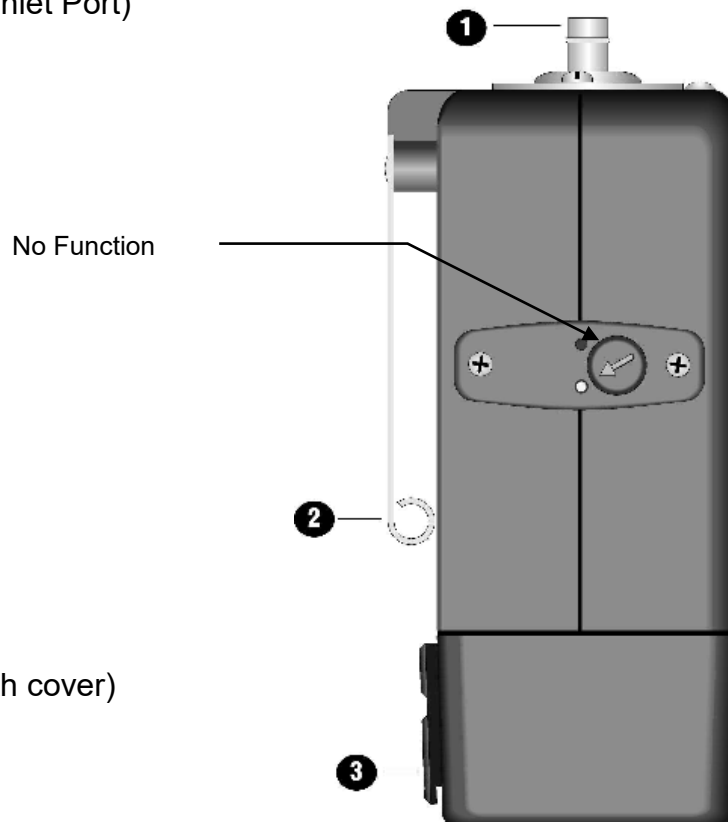

- (3) Battery Charging Jack (with cover)

(4) 4-button Keypad

(5) Indicator LED:

Green - Indicates Normal Operation (Flow rate in regulation)

Red – Indicates Fault

(6) Liquid Crystal Display (LCD)



LCD Details

- (6.1) Four 7-Segment Characters, indicating Flow Rate, Time, Volume Sampled and Messages.
- (6.2) **VOL & L.** Indicates number in display is sample volume in liters.
- (6.3) **MIN.** Indicates number in display is sample time in minutes.
- (6.4) **CC/MIN.** Indicates number in display is the set point flow rate in cc/minute
- (6.5) **SET.** Indicates the Set/Cal button is active to select the value shown in the numeric display
- (6.6) **FAULT.** Indicates a Fault Condition
 FAULT appears when pump is not able to maintain set flow rate.
- (6.6) **HOLD.** If pump is in fault for 30 seconds continuously, pump enters HOLD and the indicator appears.
- (6.7) **HRS.** Indicates number in display is duration in hours
- (6.8) **Battery Indicator.**
 3 bars = High charge
 2 bars = Medium charge
 1 bar = Low charge
 no box = imminent shut down
- (6.9) NOT USED
- (6.10) The program has been enabled.
- (6.11) Indicates a program has been enabled and will begin as soon as the pump is started. The program controls the pump to be off or on, depending on the program setup and progress, even if the motor is not running.

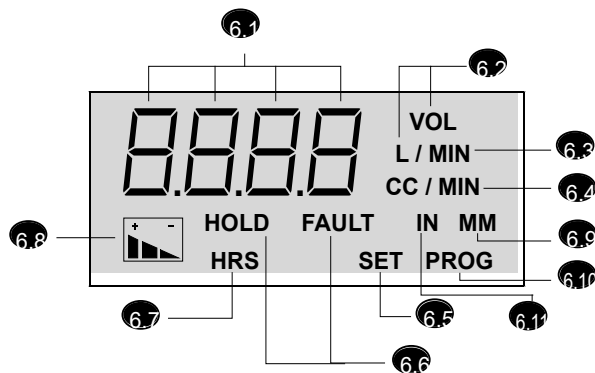

SECTION TWO

Setup

2.1 Preparation

The battery pack must be fully charged before using pump. It takes about four hours to charge the battery from complete discharge. Refer to Section Six for full battery maintenance.

Attach Sensidyne Charger PN 298-0013-01 or Five-Unit Power station to power source.

Plug charger into battery charging jack. Charging cycle will begin immediately and will complete as indicated by charger LED. Refer to charger labeling or Appendix E for full details of LED functions.

Battery pack may be charged detached or while attached to pump, through built-in jack. The pump should not be used during charging.

Caution

Both charger and battery pack become warm during charging.

DO NOT operate pump while charger is attached.

Do not short battery terminals. Shorting will blow internal fuse.

Charging and Battery removal should not be done in a hazardous location.

2.2 Pump Start-Up

Power Up

Press and release POWER button

Display will illuminate and run a Start-up Sequence, then enter Ready Mode. LED will flash red, then green as part of the startup process.

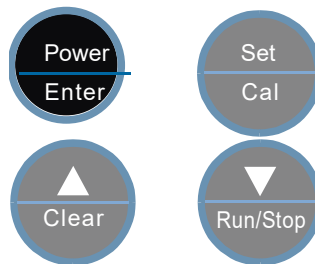

Start-Up Sequence (approx. 10 seconds):

Screen Test

This is a functional test of the entire display

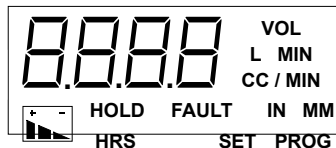

Version No.

Indicates the Version of Software installed in pump (*Current version may vary from picture. Should show version from page 1.*)

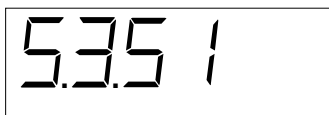

Last Cal screen

Shows number of run hours since last calibration. If more that 200 hours have passed since last calibration, the value is displayed for twice as long and blinks.



If the AutoStart option is enabled, the pump will start a sample immediately. If "dCLr" is displayed, AutoStart was selected, but unable to start because data must be cleared.



Ready Mode

In Ready Mode, display cycles through following screens:

Flow Rate Set Point or, if Auto Start was selected, the live flow rate.



Total Sample Time of the current or last event.



Total Volume Sampled of the current or last event.

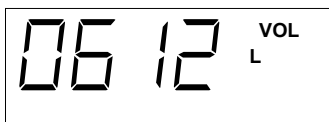

If no buttons are pushed, Ready Mode continues cycling through screens for 75 minutes then unit turns off.

Power Down

Press and hold Power button until display shows "OFF" (3-4 seconds), then release. Pump will show "OFF" for a few seconds until it powers down.

Holding Clr until the "OFF" disappears will reset all calibrations and data to factory settings.

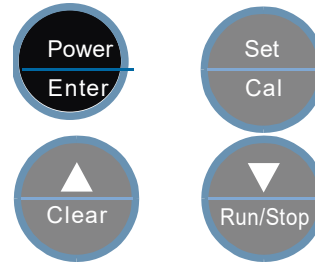

2.3 Setting The Flow Rate

NOTE

This section is required only if you are changing pump flow rate. If you're using previously set flow rate, simply verify it using a Reference Meter (see Section 2.4.2).

At Ready Mode, press SET/CAL button once. "FLO" is displayed.

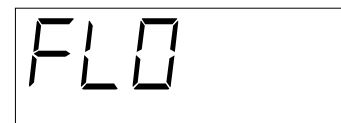

SET

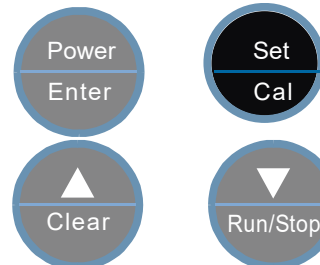

SET

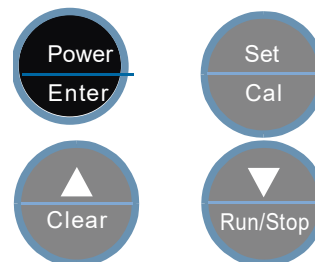

Press ENTER button to begin setting the flow rate.



Press ▲ button to increase flow rate set point or ▼ button to decrease flow rate set point, in 10 cc/min increments.

Pressing and holding ▲ or ▼ button will change setting rapidly after a short delay.

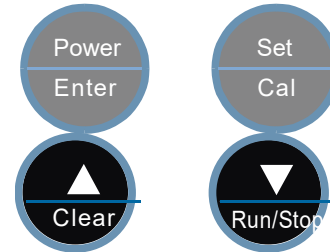

Elapsed Time and Total Volume will be cleared. When desired flow rate set point is reached press ENTER button. Pump will return to Ready Mode

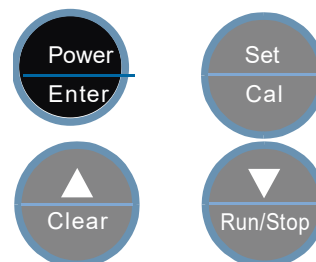

2.4 Calibration

The pump should be calibrated every 200 run hours or 30 days for optimum accuracy of the displayed flow. Calibration is also recommended when the flow rate set point has been changed. Entering calibration will reset the hours since last calibration, sample time and total volume sampled.

2.4.1 Set-Up

Set up a flow reference instrument to measure the pump flow rate, such as a Gilibrator-2, Gilibrator-3 or Go-Cal. The Gilibrator-2 is illustrated in this manual.

Choose a sample media of similar back pressure to that used in the field.

Attach 1/4" ID tubing from pump to media and from media to the reference meter.

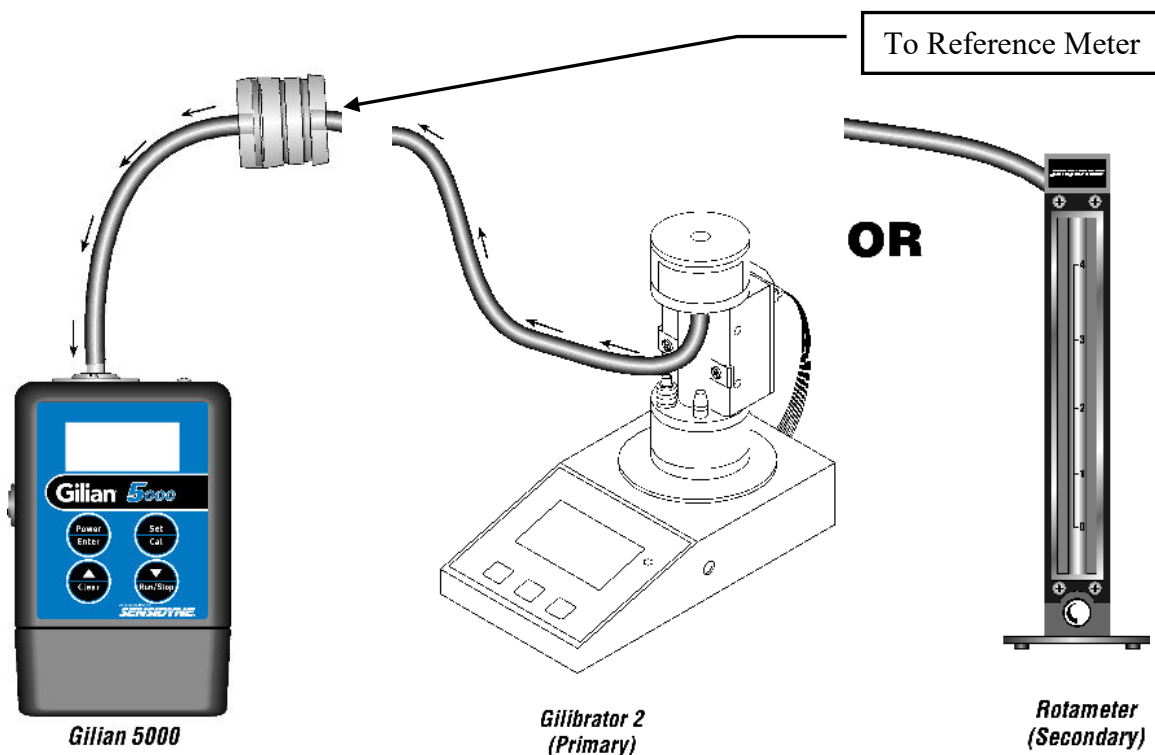

2.4.2 Display Calibration

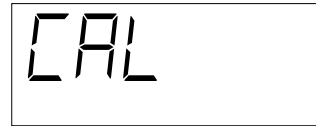

At Ready Mode, press SET/CAL button twice.

“CAL” is displayed

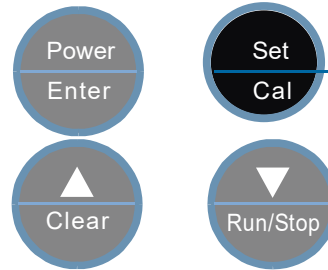

Press ENTER button to enter Calibration Mode. “SCAL” (Self-Calibration) is displayed for 10 seconds, allowing the pump to establish a zero reference for the flow control system. Pump will then start running, and display the set flow rate.

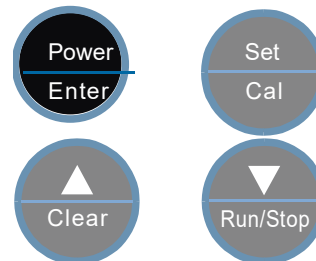

NOTE

To exit Calibration Mode without changing flow calibration, simply press ENTER. This action will also reset the hours since last calibration, sample time and total volume sampled.

Measure flow rate using reference meter.

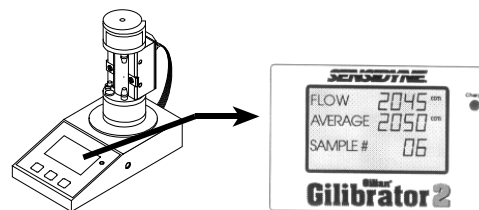

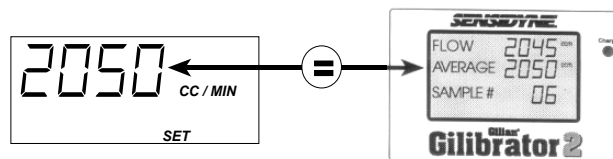

Adjust pump display to match actual flow rate on reference meter. Press ▲ button to increase. Press ▼ button to decrease.

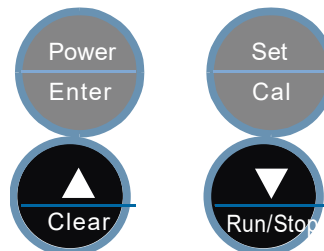

When pump display matches reference meter press SET button.



Pump motor continues running and adjusts speed to deliver adjusted flow rate. Pump display returns to the originally selected flow set point.

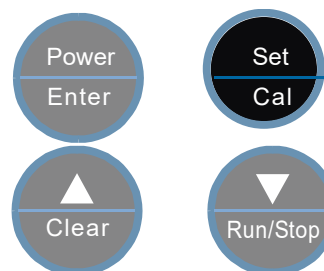

Continue to measure flow rate on reference meter. If reference does not match intended flow rate, you may repeat previous 2 steps until the actual flow rate is correct. When the flow rate is correct, proceed to next step.

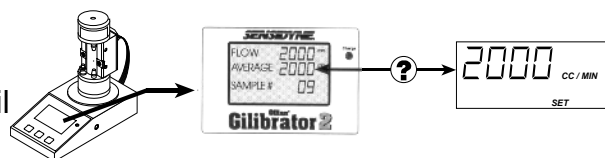

Press ENTER button to complete calibration.

The pump stops and returns to Ready Mode

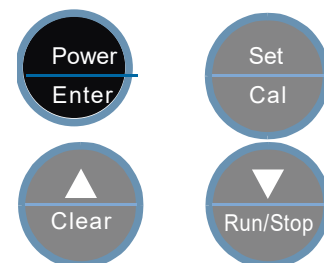

Note On Field Calibration

The above display calibration procedure serves to make internal pump adjustments and improve the accuracy of the flow display. It does not replace field calibration as described by OSHA and NIOSH. A flow verification using the Gilibrator and the exact field sampling train should be conducted before and after each field sample. Procedures for field calibration may be referenced in the *NIOSH Manual of Analytical Methods* at www.cdc.gov/niosh or in the *OSHA Technical Manual* at www.osha.gov.

SECTION THREE

Program

The program capability allows a time based sampling program to be set and executed. From the time it is initiated until it completes the program or is canceled, the pump will use the programmed time sequence to turn the pump on and off at specified intervals. All programs specify the flow rate, run duration and an “OFF” between interval steps. Only the first step has a delay time. If option 4 is enabled, the program will consist of a single run interval. If option 4 is disabled (the default setting) the program consists of four sequential program segments each specifying an on-period and off-period, ending with a cycle count that will repeat the four on/off intervals the designated number of times.

Each on/off interval is set to a number of minutes. If any interval, other than the delay, is specified as zero it terminates that cycle of the program, even if there are non-zero intervals at later points in the program. After each cycle ends, the cycle count is evaluated and the program terminates or the next cycle starts. Setting a cycle count of zero is not significant and one cycle will be executed, exactly as if the cycle count were set to one.

At each interval there is an SCAL (Self-calibration), which takes ten seconds to establish a zero reference for the flow control system. The pump does not run during the SCAL and this time is not counted as part of the program or the sample.

If a flow fault occurs and the pump enters “HOLD”, the time that elapses while the pump is halted is not counted in the sample runtime, but is counted by the program timer. During this Fault Activated HOLD time, the unit will attempt to restart every 3 minutes. If the “on” interval for a segment has not expired, Hold restarts are enabled, and the fault condition has been corrected, the pump will restart and continue and complete the on-interval. If the on-interval expires before the three minutes elapses, the pump will not restart as it has entered the next off-interval. The pump will restart at the next on interval if one occurs. Up to 10 restarts will be attempted before the program is terminated.

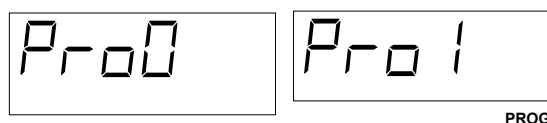

3.1 Programming

At Ready Mode, press SET/CAL button three times. “Pro0”, program disabled or “Pro1”, program enabled, is displayed.

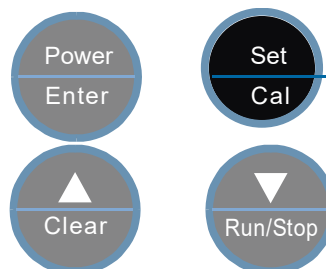

3.2 Program enable/disable

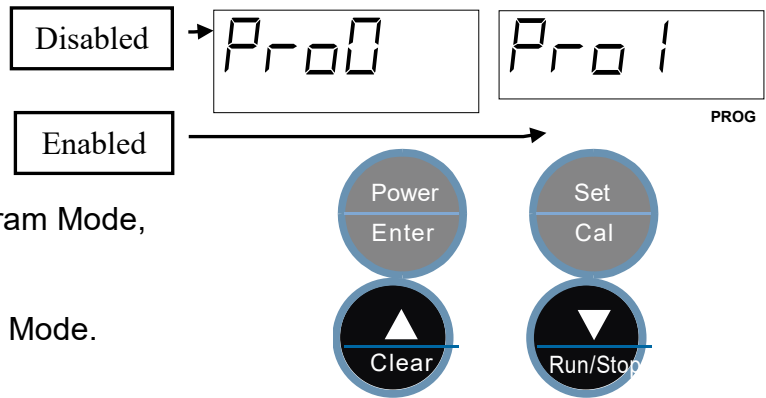

Press the ▲ button to enable Program Mode, “Pro1” and “PROG” are displayed.

Press ▼ button to disable Program Mode. “Pro0” is displayed.

NOTE: If program is not to be edited, press the enter button repeatedly to advance through the programming options and return pump to ready mode.

3.3 Program Editing

The program capability is controlled by the Option 4 setting. If the option is disabled (default) there are eleven program parameters. If Option 4 is enabled ("single run"), there are three parameters. Program editing proceeds through each separate numeric parameters. Press ENTER button to begin setting of parameters.

Press the ▲ button to increase each parameter or ▼ button to decrease each parameter. Press the ENTER button to accept each setting and move to next parameter.

The parameters are as follows:

Note: If any interval is set to 0.000, the program will skip to the cycle count.

	Parameter Name	Display	Parameter Range
	Flow rate	0000	800-5000 cc/min
	Delay Time before start	d.000	0-999 minutes
Seg 1	On Time, Segment 1	1.000	0-999 minutes
Seg 1	Off Time, Segment 1	.000	0-999 minutes
Seg 2	On Time, Segment 2	2.000	0-999 minutes
Seg 2	Off Time, Segment 2	.000	0-999 minutes
Seg 3	On Time, Segment 3	3.000	0-999 minutes
Seg 3	Off Time, Segment 3	.000	0-999 minutes
Seg 4	On Time, Segment 4	4.000	0-999 minutes
Seg 4	Off Time, Segment 4	.000	0-999 minutes
	Cycle count	C.000	0-999 number of cycles to run

If a parameter is modified, the program is saved to non-volatile memory and preserved. After the last parameter, the pump returns to Ready mode.

SECTION FOUR

Options

Options allow the functionality of the pump to be modified. Each option can be set to On (1) or Off (0). The option settings are stored in nonvolatile memory and preserved over power down and battery changes.

The options are listed below, i.e. o.0.01 (Off) or o.1.01 (On).

Note: All options are set to the default (Off) at the factory.

4.1 Options List

Option	Option Title	Option Description	
01	Fault Hold Lock	If set to On, and the pump goes into Fault for any reason, the pump will be locked in Fault Hold and will not try to restart. If set to Off, the pump will try to restart 3 minutes after entering Fault Hold.	Default Off (0) o.0.01
02	Auto Lock	If set to On, the program will enter Keyboard Lock when a manual or programmed sample is started, the keyboard can be unlocked as described in section 5.4.	Off (0) o.0.02
03	Auto Start	If set to On, the pump will start a sample when turned on. If sample data has not been cleared, the pump will display "dCLr" and enter idle mode.	Off (0) o.0.03
04	Single Event Program	If set to On, the program will specify flow rate, delay time and a single on time ("Single Event"). If set to off, the program will be full length with 4 on/off segments and a cycle counter.	Off (0) o.0.04
05	SCAL Disable	If set to On. The hourly SCAL flow rate will not be done. The periodic SCAL events improve stability.	Off (0) o.0.05

4.2 Option Settings

At Ready Mode, press SET/CAL button four times. "OP" is displayed.

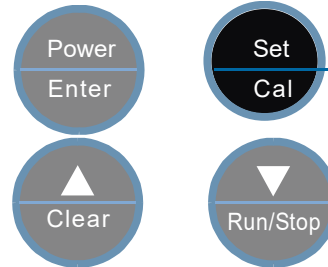

Press ENTER button to set indicated option.

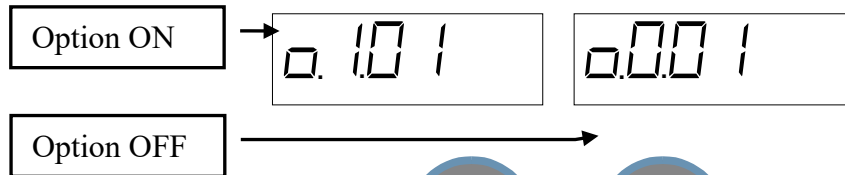
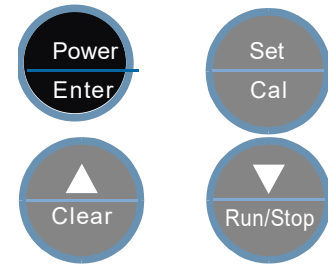

Press ▲ button to turn On indicated Option (o.1.xx on display),
 press ▼ button to turn Off Option (o.0.xx on display).

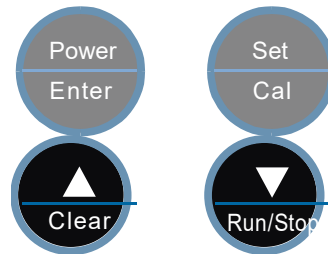

Press ENTER button to accept setting, and advance to Option 2.

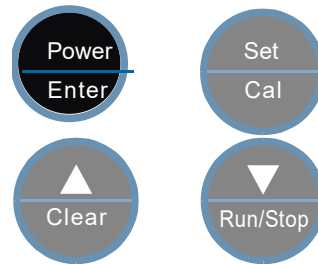

Edit additional Options in the same manner as Option 1.

Press ENTER to advance to remaining Options.



Press ENTER to continue to Ready mode.

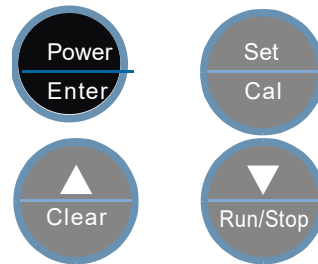

All option changes will be saved when the power key is used to shut down the pump. Removing the battery without power shutdown, will cause any unsaved changes to be lost.

SECTION FIVE

Operation

5.1 Starting The Sample Run

NOTE: Total Run Time and Total Volume Sampled are cumulative from one sample run to the next unless you reset the flow rate, clear the display, or calibrate the display. If you want to clear the values before starting a sample run, see Section 5.5 for instructions on clearing the run data.

Make sure pump is fully charged, that flow rate has been properly set, and that the pump has been field calibrated using actual sampling set-up. Make certain all sample tubing and any sample media have been properly installed.

If programmed operation is desired, enable and configure according to section 3. When program mode is enabled, “PROG” is displayed and starting the pump will begin the program. “PROG” will remain displayed until program mode is disabled or pump is turned off. If “PROG” is not displayed the pump will start in manual mode.

Program Mode:

Press and **hold** the RUN button until “IN” is displayed.

“IN” signifies the pump is in a program and will be displayed until the program is complete or the pump is stopped.

“Pro1” will appear momentarily and will be added to the rotation of displays shown, while in a program. Once the program is complete, “Pro1” will not be displayed.

If the “delay” program setting is zero, the pump will start immediately; if a delay has been programmed, the delay will start.

At each program on time, “SCAL” (as described in Manual Mode) will be displayed.

When program is complete, pump will return to ready mode, with program enabled (“PROG” displayed). To run program again, Press and Hold the RUN button. If Program mode is no longer desired, disable according to section 3.

After the program starts, the controls may be locked if desired. (described in section 5.3)

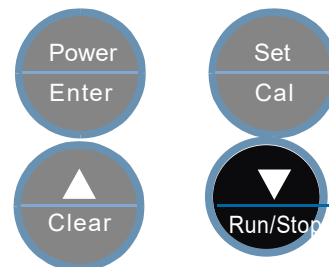
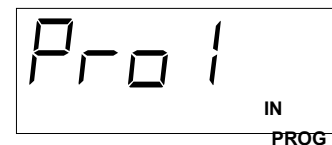

Manual Mode:

Press and **hold** the RUN button until “SCAL” is displayed, then release button. Pump will start 10 seconds later. **Note:** “SCAL” indicates pump is doing an internal Self Adjustment. This self-adjustment may occur during the course of a sample if the temperature changes by more than 3°C. The pump is not operating and the clock does not count the time while pump is in SCAL mode.

After the program starts, the controls may be locked if desired. (described in section 5.3)

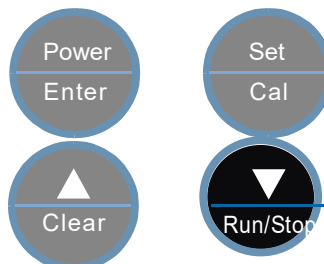
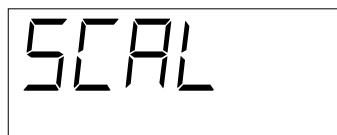

During sampling, pump alternately displays following screens:

Live Flow Rate



Total Run Time



Total Volume Sampled (liters)

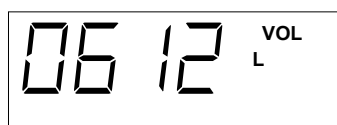

Program Mode
(Only displayed while a program is active)

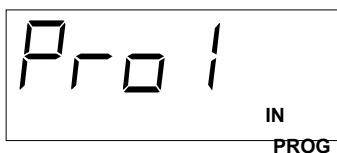

5.2 Stopping The Sample Run

Press and **hold** the STOP button until pump motor stops.

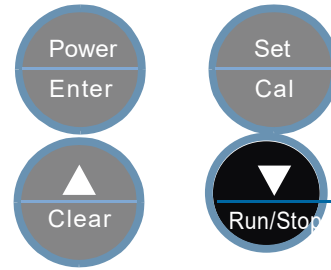

Pump alternately displays following screens:

Set Flow Rate

2000 CC / MIN

Total Run Time

0498 MIN

Total Volume Sampled (liters)

0996 VOL
L

NOTE

If the pump motor does not stop, go to Section 5.4 to unlock the keypad.

If pump is in “READY” mode, you may power down by pressing and holding the POWER button for 4-5 seconds. The display will show “OFF” before shutting down. Sample data will be retained until the clear run function is performed (section 5.5).

5.3 Locking The Keypad

The keypad can be locked to prevent tampering.

To lock, press and **hold** both SET/CAL and ▲/CLR buttons for 5 seconds until “LOCK” is displayed.

Note: Keypad cannot be locked during “SCAL”.



SET

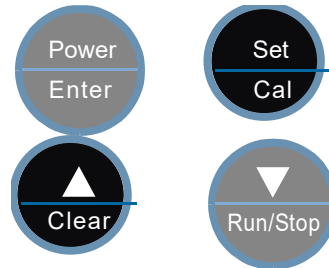

5.4 Unlocking The Keypad

To unlock, press and **hold** both SET/CAL and ▲/CLR buttons for 5 seconds until “UnLK” is displayed.



SET

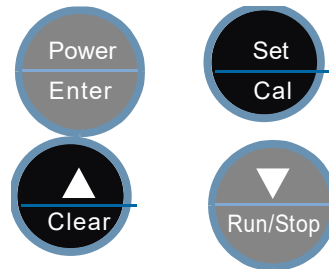

- Note: The word “LOCK” will replace the TOTAL VOLUME SAMPLED on display.

5.5 Clearing The Run Data

In Ready Mode, press and hold ▲/CLR button. “CLr” will be displayed and flash for a total of 8 seconds. When Flow Rate is displayed, release button. Data will be cleared and pump will return to Ready mode.

Releasing the CLEAR button during the 8 seconds (before flow rate is displayed), will retain data.

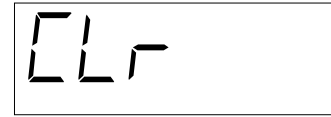
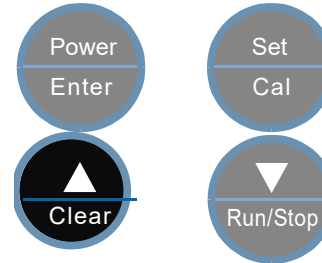
Total Run Time (Cleared)



Total Volume Sampled (Cleared)



NOTE

If you remove the battery pack before powering down the pump, all stored data will be lost.

Changing the flow rate will also clear previous run data.

5.6 Flow Calculation

The Gilian 5000 calculates the total air volume sampled using the following formula:

$$\text{Total Air Volume (Liters)} = \text{Air Flow Rate (AFR) (cc/min)} \times \text{Sample Time (ST) (minutes)} / 1000 \text{ (cc/Liter)}$$

OR

$$\frac{\text{AFR} \times \text{ST}}{1000}$$

SECTION SIX

Maintenance

6.1 Battery Maintenance

NOTE

Do not charge or replace battery pack while in an explosive atmosphere. Use only Sensidyne charger PN 298-0013-01 or other charger designated for Gilian 5000.

The Gilian 5000 pump uses rechargeable Nickel-Metal-Hydride batteries that must be fully charged and properly maintained for maximum run time. The battery pack has a charge time under 4 hours using Fast Charger (PN 298-0013-01). Battery pack may be charged separately or while on the pump.

Make certain charger plug is fully inserted into jack on battery pack (see #3 in Components of Section 1, for charger jack location).

See Appendix E for more information on charger operation.

After charging is complete, make certain the rubber jack cover is plugged back into the charging jack to protect the jack during operation.

CAUTIONS & NOTES

Both charger and battery pack become warm during charging.

Charger switches automatically to trickle mode when battery is fully charged.

DO NOT operate pump while charger is attached.

Do not short battery terminals. Shorting will blow internal fuse.

All NiMH batteries lose charge when not in use. If battery pack has not been charged for 3-4 days, recharge battery before use. This ensures that batteries are fully charged just prior to sampling. NiMH batteries stored for extended time periods should be recharged every 1-2 months to avoid complete discharge.

Battery pack has an estimated life of 300–500 charge/discharge cycles, depending on use. Table below shows estimated battery life based on usage level.

Pump Usage Weekly Use Est. Battery Life

High	40-60 hrs	1.0-1.5 yrs
Medium.....	20-39 hrs	1.5-2.5 yrs
Low	< 20 hrs	2.5 yrs

Note: Disconnecting the battery from the pump will prolong battery life if stored for extended periods > 2 months.

6.2 Pump Filter Maintenance

Change internal pump filter PN 811-0012-01 when it is dirty or damaged. Reuse o-ring and ensure it is properly seated when reinstalling.

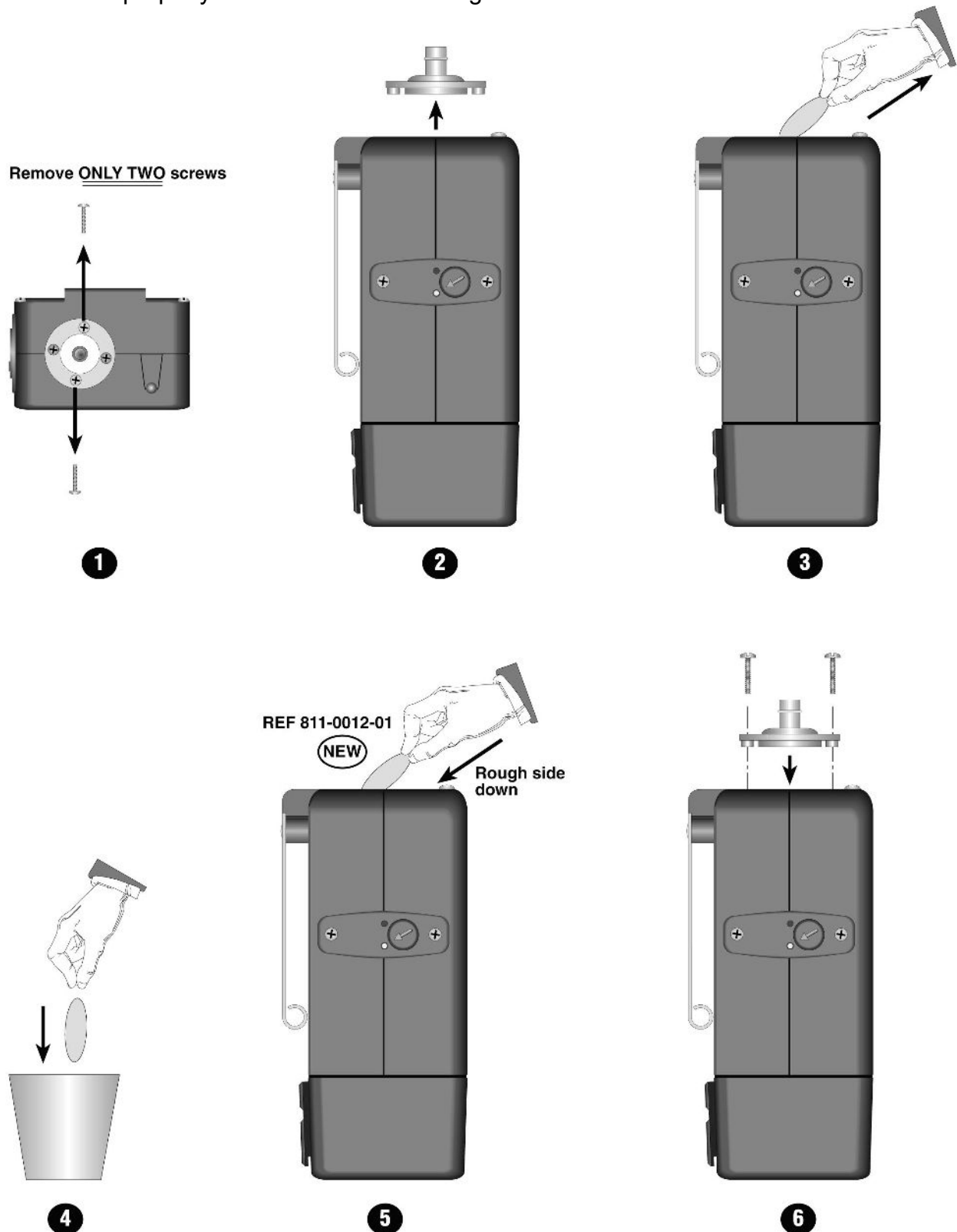

APPENDIX A

Troubleshooting Guide

<u>Symptom</u>	<u>Possible Cause</u>	<u>Corrective Action</u>
Pump will not turn on	Low battery charge Blown fuse in battery Dead Cells in battery Control board problem	Charge battery Replace battery Replace battery Return for service
Pump shows Fault in display/Enters HOLD	Inlet filter clogged Intake obstructed Back pressure too high Control board problem Flow rate is set too high for sample media Sample media tubing pinched shut	Replace Filter Examine sample holder and remove obstruction Run @ lower flow rate Return for service Correct the flow rate per sample method guidelines Correct tubing kink
Pump runs flat out	Internal flow transducer disconnected Control board problem Bad Calibration	Return for service Return for service Recalibrate
Pump will not make flow specs	Valve dirty or torn Torn diaphragm on Yoke assembly Leak in pump Battery not sufficiently charged Leak in sample media/train	Return for service Return for service Input manifold screws may not be tight after replacing input filter. Return for service if tightening screws does not solve leakage issue Charge battery Repair leak
Pump runs erratic & faults	Faulty bearing Faulty motor Liquid in pump Charger connected	Return for service Return for service Return for service Don't run pump with charger connected

APPENDIX A

Troubleshooting Guide

Pump surges	Display calibration adjusted out of range Charger connected	Reset display calibrations to factory setting (see procedure at end of table) Don't run pump with charger connected
Pump will not run program; Pro1 flashes briefly	Program time is set to zero	Enter non zero program duration
Keyboard inoperative	Keyboard is locked Pump in off phase of program	Unlock keyboard (keyboard may lock automatically if AutoLock option is turned on) Wait for program to complete or stop program
Pump stops occasionally and restarts after 10 seconds	Normal operation. Flow control is being rezeroed.	Wait 10 seconds for restart or disable "SCAL" per Section 4
Displayed flow rate does not match calibration	Flow display is out of calibration Leak in sample media	Calibrate Repair leak
Pump will not run at desired flow rate with low flow adapter in place	Wrong sample tube holder selected for constant pressure control adapter	Select tube holder that incorporates a needle valve
Pump starts when power is turned on	Auto Start option turned on	Turn Auto Start option off
"dCLr" displayed when power turned on	Auto Start option turned on and data in pump not cleared at the end of run	IF Auto Start desired, clear data to allow pump to start at power on. If Auto Start not desired, turn option off.

To reset display calibration, Turn off pump power, when Off appears in display press and hold Clr key, Clr will appear and flash, continue holding key until display blanks.

APPENDIX B

Parts List

Spare Parts & Accessories

Part Number	Description
811-0802-01	Single Charger 100-240Vac, 50-60 Hz, US Cord
811-0802-02	Single Charger 100-240Vac, 50-60 Hz, Euro Cord
811-0802-03	Single Charger 100-240Vac, 50-60 Hz, UK Cord
298-0013-01	Single Charger 100-240Vac, 50-60 Hz, No Cord
811-0801-01	Five Unit Power Pack 100-240Vac, 50-60 Hz, US Cord
811-0801-02	Five Unit Power Pack 100-240Vac, 50-60 Hz, Euro Cord
811-0801-03	Five Unit Power Pack 100-240Vac, 50-60 Hz, UK Cord
811-0801-04	Five Unit Power Pack 100-240Vac, 50-60 Hz, No Cord
783-0007-01	Battery Pack
811-9961-US	Power Module, Gilian 5000/800i/10i, US Cord
811-9961-EU	Power Module, Gilian 5000/800i/10i, Euro Cord
811-9961-UK	Power Module, Gilian 5000/800i/10i, UK Cord
811-9961-NO	Power Module, Gilian 5000/800i/10i, No Cord
800143	Filter Cassette Kit
811-0012-01	10 Filters
360-0103-01	Operation Manual
360-0104-01	Quick Start Guide
801961	Low Flow Adapter
801980	Fixed Mount Assembly
800573-3	Calibration Panel Assembly (50-200-5 LTR)
800573-100	Calibration Panel Assembly (100" Magnehelic)
800149	Tube Holder Kit, Single Tube Holder Kit (No Manifold), 6 x 70 mm
800259	Tube Holder Kit, Single Tube Holder Kit (No Manifold), 7-10 x 110 mm
800148	Tube Holder Kit, Dual Manifold (Holders/Ends/Tubing), 6 x 70 mm
801407	Tube Holder Kit, Dual Manifold (Holders/Ends/Tubing), 10 x 110 mm
200484	Tubing, 36", 1/4" ID
800159	Tubing, 36", 1/8" ID (with 1/4" ID adapter)
200505	Tubing, 36", 1/8" ID

APPENDIX C

Specifications

Performance

Operating High Flow Range	700–5000 cc/min
Accuracy	± 5%
Constant Flow control	< ± 5% of set flow (after calibration) between 1-5 LPM up to pressures listed below;
Constant Flow Compensation	5000cc/min up to 24" water back pressure (2 hour runtime at this flowrate/backpressure) 5000cc/min up to 20" water back pressure 4000cc/min up to 30" water back pressure 3000cc/min up to 50" water back pressure 2000cc/min up to 60" water back pressure 1000cc/min up to 70" water back pressure
Flow Fault.....	If flow changes exceed 5%, fault icon appears. If fault exceeds 30 seconds, pump shuts down. If Enabled: Pump attempts to restart every 3 minutes for up to 30 minutes.

General

Controls.....	Power/Enter, Set/Cal, ▲/Clear, ▼/Run/Stop
Indicators.....	Blinking Green Indicates Normal Operation while running, no green LED Indicates Fault
Icons (LCD)	Battery Indicator, Hold, Fault, Set
Dimensions	3.2" (W) x 5.4" (H) x 2.3" (D)
Weight.....	19.5 oz.
Display (Normal Operation).....	Live Flow, Elapsed Time & Volume Sampled
EMC EMI/RFI	EN61326-1:2013 FCC Part B, Class A IECS-003 Class A
ISO13137:2013.....	Type P Compliant

Electrical

Battery Pack.....	Removable, Sealed, Rechargeable Nickel-Metal-Hydride (6 cells)
Battery Level Indicator	Icon displays Full, Mid, & Low charge levels
Interface Connectors.....	Charging Jack
Charge Time	< 4 hours

APPENDIX C

Specifications

Intrinsic Safety

US/Canada	Class I, Div 1, Groups A, B, C, D Class II, Groups E, F, G Class III, T3 Ta= -20°C to 45°C CL I, Zn 0, AEx/Ex ia IIC T3 Ga FM17US0133 FM17CA0073
Europe	ATEX II 1 G, Ex ia IIC T3 Ga Ta= -20°C to 45°C FM 07ATEX0018 IECEX FMG17.0013

Environmental

Temperature

Operating	0°C to 45°C (32°F to 113°F)
Storage	-20°C to 45°C (-4°F to 113°F)
Charging (max).....	5°C to 40°C (41°F to 104°F)
Charging (for best charge and life) ..	5°C to 30°C (41°F to 90°F)

Humidity

Operating	0–85 %RH, non-condensing
Storage	0–98 %RH, non-condensing

APPENDIX D

Low Flow Adapter

Direct Installation to Gilian 5000

Caution: To prevent kinking, connection between low flow adapter PN 801961 and Gilian 5000 should be as short as possible. The two air boss connections should nearly touch inside the tubing.

Note: The low flow adapter may also be installed at the lapel end of the sampling tube close to the sample holder.

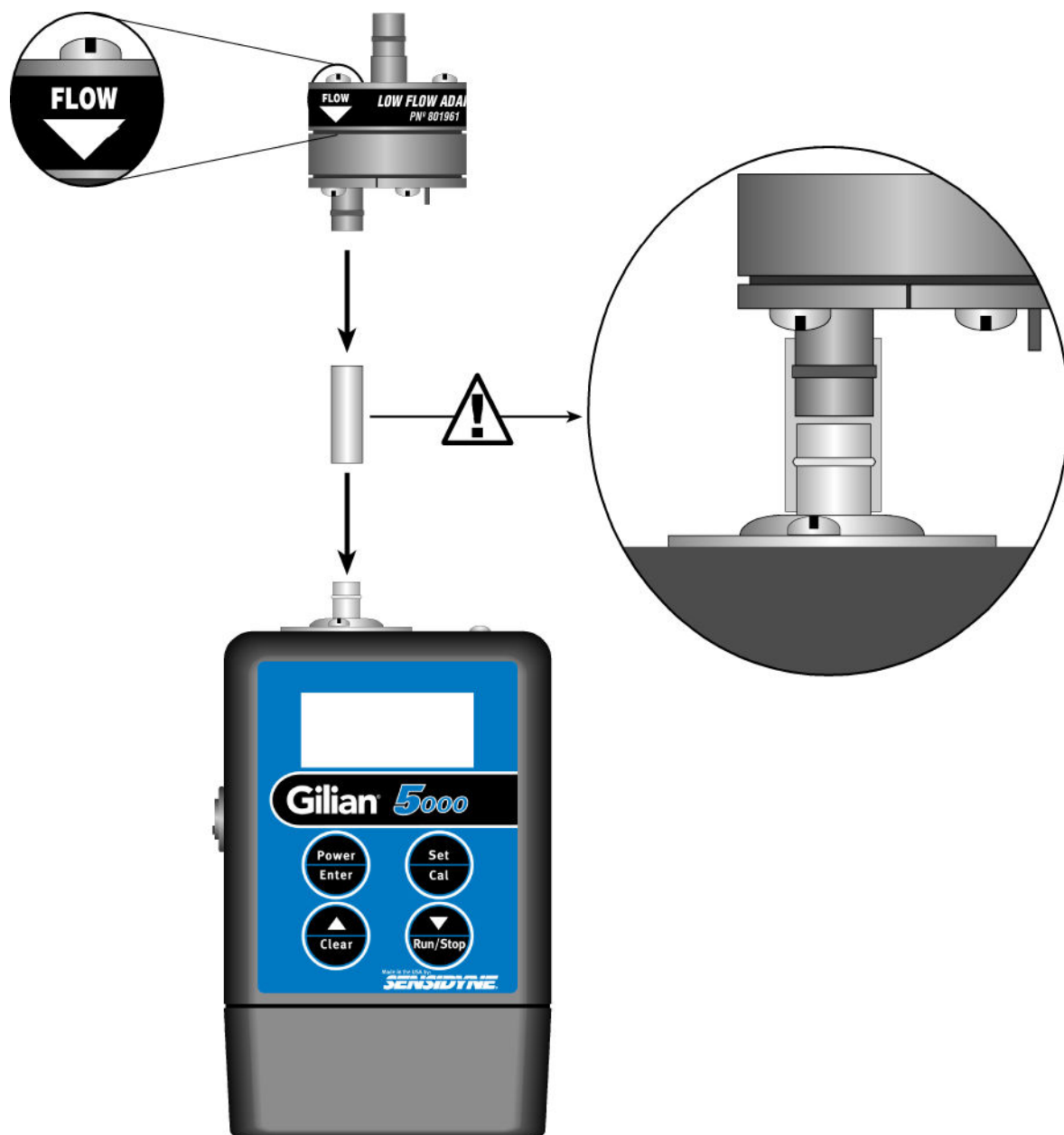

APPENDIX D

Low Flow Adapter

Installation To Gilian 5000 Using Fixed Mount Assembly PN 801980

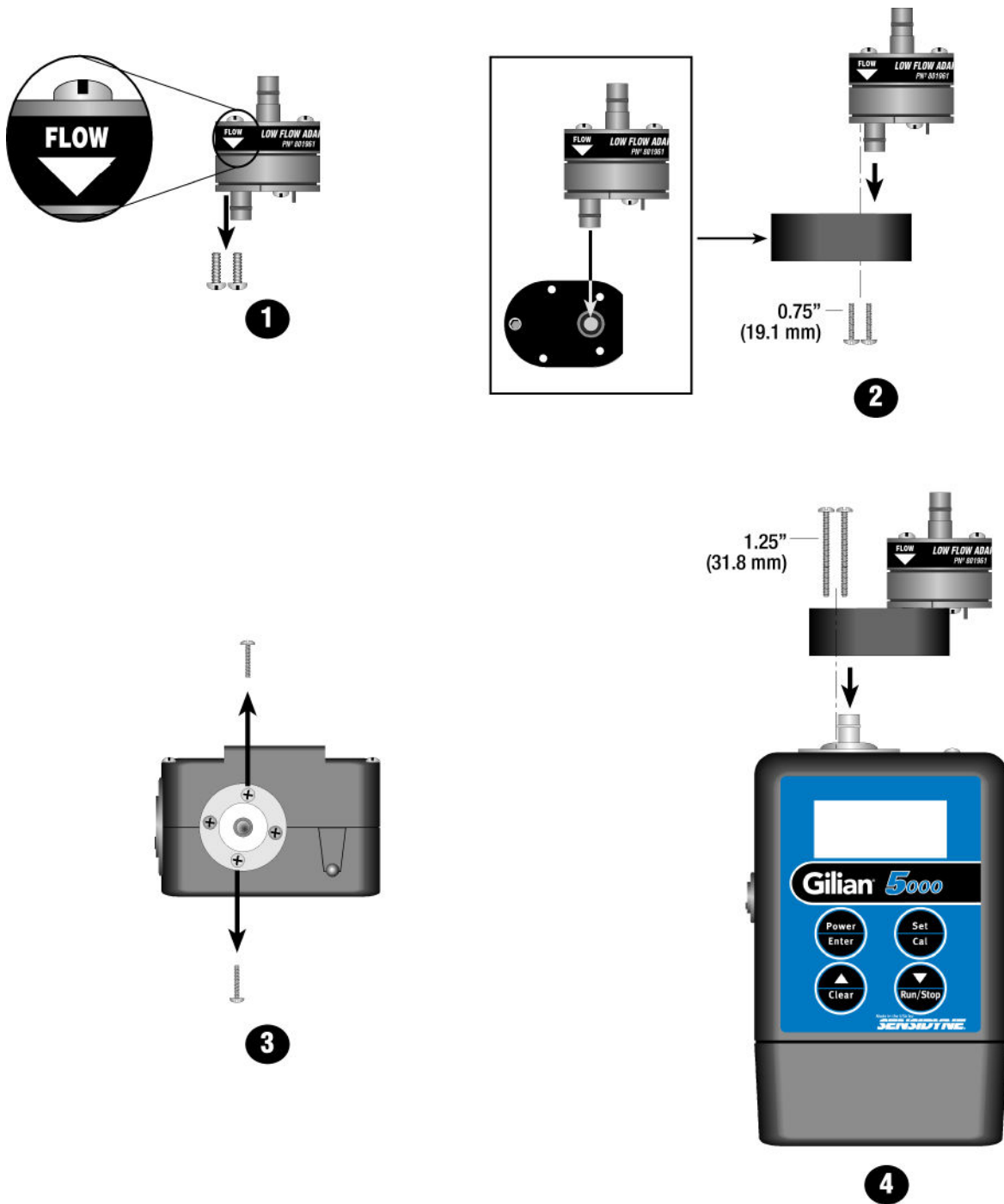

APPENDIX D

Low Flow Adapter

Filter Maintenance

Change Low Flow Adapter filter PN 811-0012-01 when it is dirty or damaged.

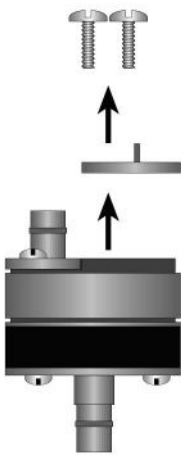
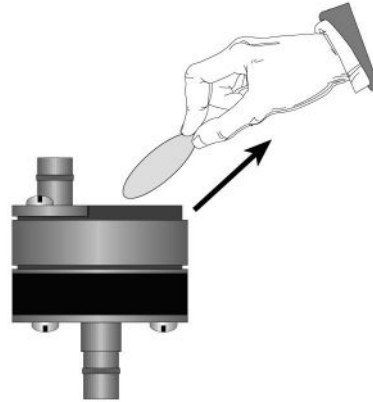
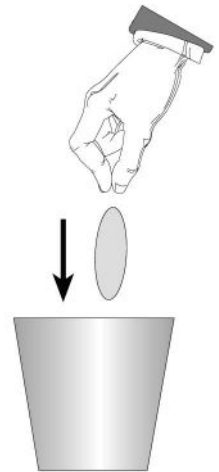
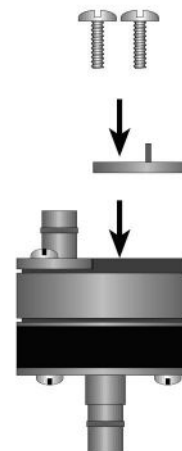
**1****2****3****4****5**

APPENDIX D

Low Flow Adapter

Low Flow Operation Example

Set flow rate on pump to 1500 cc/min (Section 2.3). Calibrate pump using appropriate back pressure (Section 2.4). Attach low flow equipment as shown. Remove tube holder manifold caps. Adjust the flow rate for each tube at the manifold.

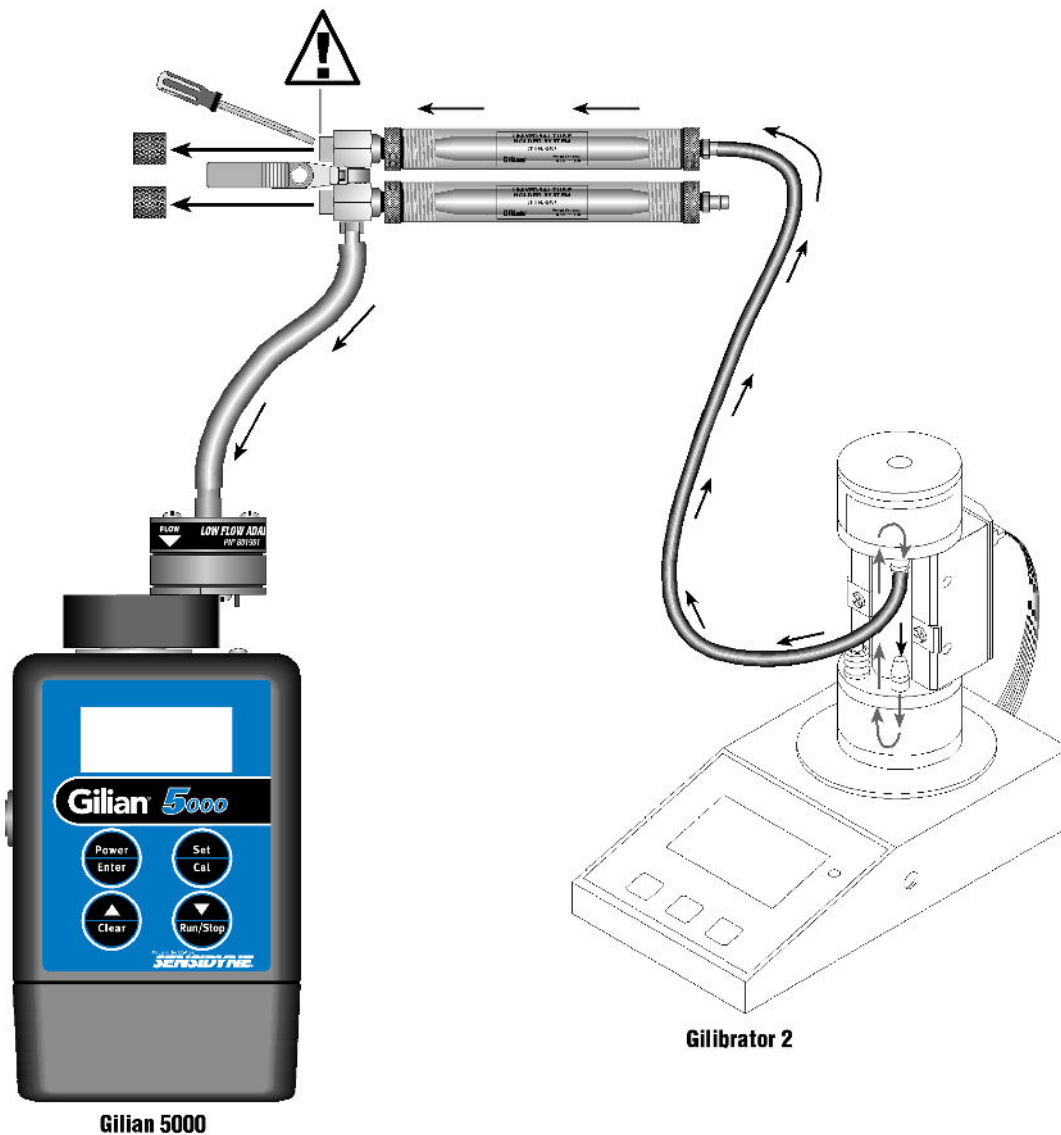

APPENDIX E

Fast Charger PN 298-0013-01

The fast charger is available as a single unit and with a five unit power station.

The fast charger is a universal input (100 - 240 VAC, 50-60Hz) charger with the capacity to rapidly charge NiMH battery packs. It delivers 1 amp in fast charge mode and monitors the battery for dV/dt changes to terminate charge when the battery reaches full charge. After the completion of fast charge, charging current is reduced and the battery is topped off for a fixed time. After completion of top off, the battery enters a trickle charge mode that automatically maintains full charge. Before charging starts, the charger makes sure the battery is able to be fast charged by measuring the cell voltage; if the cell voltage is too low, the battery is trickle charged until the cells are conditioned for fast charge.

Warning: Before charging battery, check to be sure that the charger is idle (LED indicator orange). The charger cycle will initiate correctly only if started from Idle mode. The charger will change to Idle mode after being disconnected from the battery for about 20 seconds. Plugging charger into battery pack while charger is not in idle mode will result in an incomplete charge.

Indicator

Orange	Idle; No connection or bad battery; Initialization of charge cycle
Red	Fast charge
Green/Orange flash	Top off charge
Green	Trickle charge
Orange/Green flash	Charge cycle error (typically battery fault)
Red flashing	Internal charger fault

APPENDIX F

Factory Calibration & Service

USA

**Sensidyne, LP
1000 112th Circle, Suite 100
St. Petersburg, Florida 33716 USA**

800-451-9444

727-530-3602

727-539-0550 [Main fax]

727-538-0671 [Service fax]

e-mail: info@sensidyne.com

web: www.Sensidyne.com

THIS PAGE INTENTIONALLY LEFT BLANK

THIS PAGE INTENTIONALLY LEFT BLANK

Manufactured by:

Sensidyne, LP
1000 112th Circle N, Suite 100
St. Petersburg, Florida 33716
USA

800-451-9444 • 727-530-3602 • 727-539-0550 [fax]
www.Sensidyne.com • info@sensidyne.com

Authorized EU Representative

Schauenburg Electronic Technologies GmbH
Weseler Str. 35 · 45478
Mülheim-Ruhr Germany

+49 (0) 208 9 99 10 • +49 (0) 208 5 41 10 [fax]
www.schauenburg.com • international@schauenburg.com