

AA Series Micro Air Pump: Part No. AA060INSN (Pressure) Specifications

	Minimum Free Flow	Minimum Pressure @ Dead Head	Maximum Current @ Free Flow
Model 30	1210 cc/min	2.3 psig (159 mbar)	100 mA
Model 40	1605 cc/min	3.7 psig (255 mbar)	125 mA
Model 50	1720 cc/min	6.9 psig (476 mbar)	145 mA
Rated Voltage	6.0 volts DC		
Motor Construction	Iron Core		
Diaphragm Material	Neoprene (EPDM and Viton also available)		
Pump Body Material	Ryton		
Operating Temperature Range	32°–122°F (0°–50°C)		
Weight	1.2 oz (35 grams)		
Size	1.4 cubic inches		
Options	Counterweight (for vibration reduction); Four Port Locations; Ports for 3/32" (2.4 mm) I.D. Tubing.		

DIMENSIONS

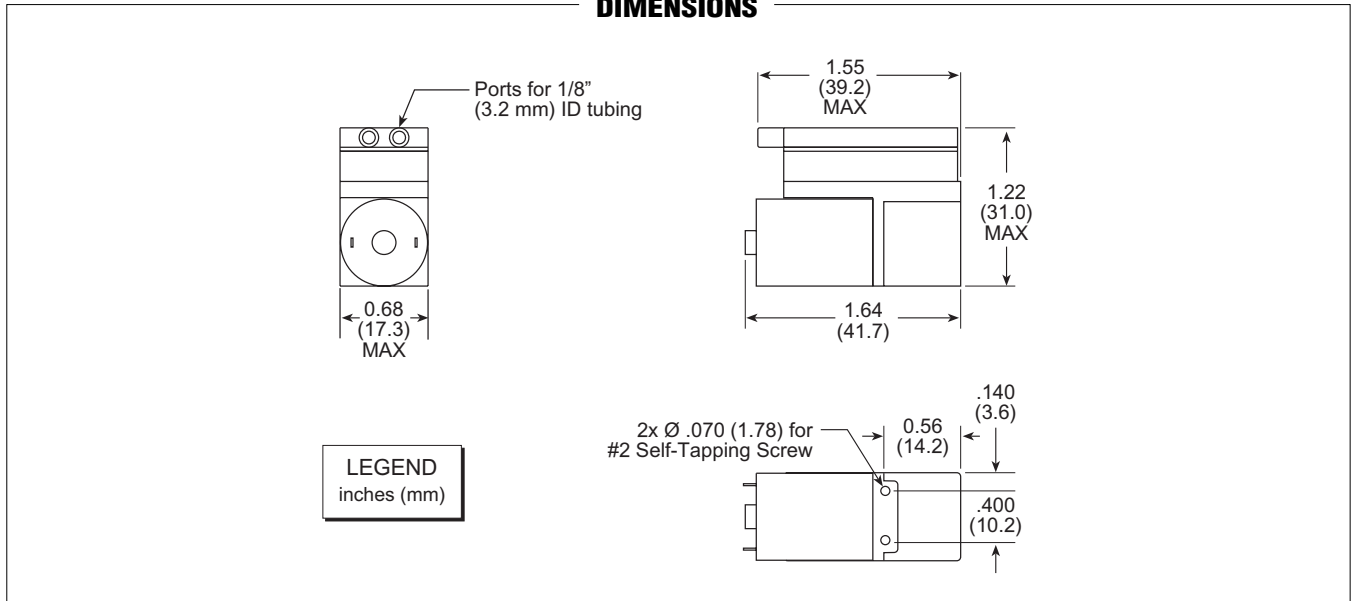

PERFORMANCE

