

C Series Micro Air Pump: Part No. C120CNSN (Pressure) Specifications

	Minimum Free Flow	Minimum Pressure @ Dead Head	Maximum Current @ Free Flow
Model 60	11.0 LPM	14.0 psig (965 mbar)	310 mA
Rated Voltage	12.0 volts DC		
Motor Construction	Ironless rotor, Ball Bearing		
Diaphragm Material	Neoprene (EPDM and Viton also available)		
Pump Body Material	Valox		
Operating Temperature Range	32°–122°F (0°–50°C)		
Weight	10.2 oz (290 grams)		
Size	15.3 cubic inches		
Options	Four Port Locations, Vibration Mounts, Ports for 3/16" ID Tubing		

DIMENSIONS

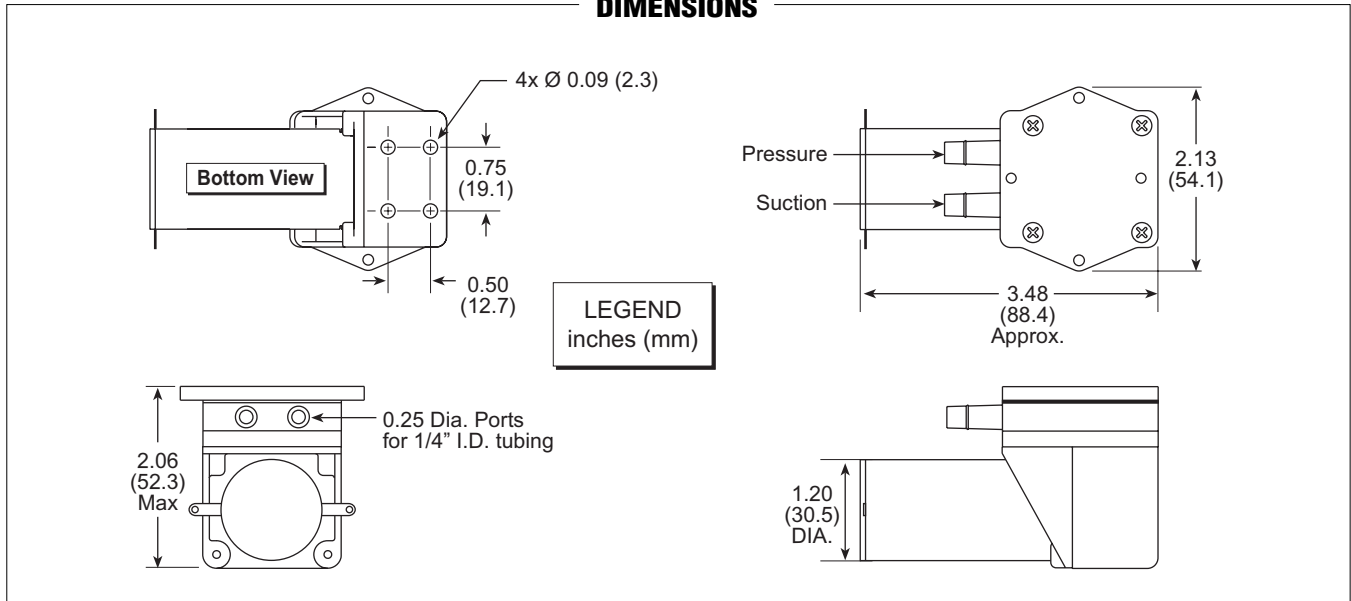

PERFORMANCE

