

**ASPIRATED SAMPLE DRAW
ACCESSORY
User Manual**

Document No. 360-0155-02, Rev E

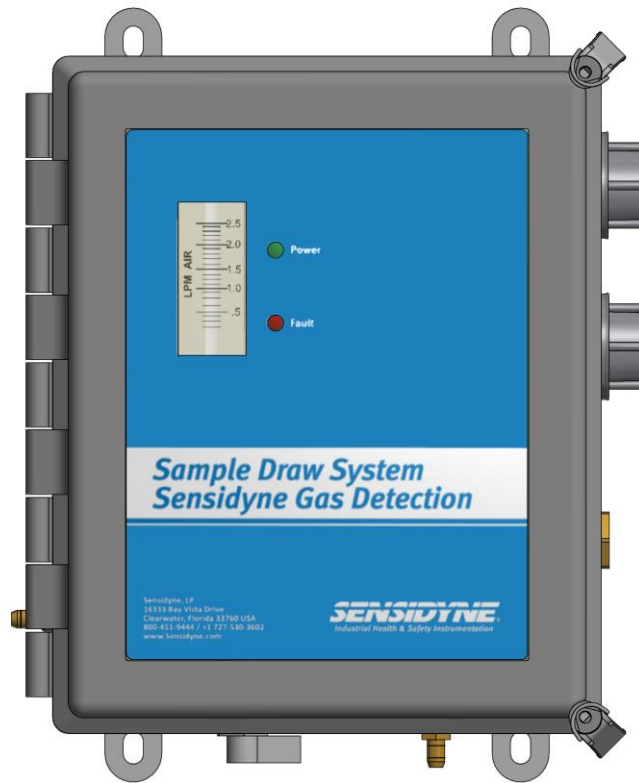

IMPORTANT

Make certain you first read and understand 1) the Operation & Service Manual for your Sensidyne Transmitter (particularly all warnings and precautions), and 2) these instructions before attempting to install or operate the Sample Draw unit.

SENSIDYNE[®]

Sensidyne, LP
1000 112th Circle N, Suite 100
St. Petersburg, Florida 33716 USA
Tel: 800-451-9444 / +1 727-530-3602 • Fax: +1 727-539-0550 [fax]
web: www.Sensidyne.com • www.SensidyneGasDetection.com
e-mail: info@Sensidyne.com

Notices

If you have any questions or need assistance, contact your Sensidyne Representative, or call 800-451-9444 or +1 727-530-3602

PROPRIETARY NOTICE

This manual was prepared by Sensidyne, LP exclusively for the owner of the sample draw unit. The material within this manual is the proprietary information of Sensidyne, LP and is to be used only to understand and operate the instrument. By receiving this document, the recipient agrees that neither this document nor the information disclosed within nor any part shall be reproduced or transferred, physically, electronically or in any form or used or disclosed to others for manufacturing or for any other purpose except as specifically authorized in writing by Sensidyne, LP.

COPYRIGHT NOTICE

©2012, Sensidyne, LP All rights reserved. Information contained in this document is protected by copyright. No part of this document may be photocopied, reproduced, or translated to another program or system without prior written authorization from Sensidyne, LP

TRADEMARK NOTICE

Sensidyne, the Sensidyne logo, SensAlert, SensAlert Plus & SensAlert ASI logos, T-O-D & Test-on-Demand are registered trademarks of Sensidyne, LP. The trademarks and service marks of Sensidyne, LP are protected through use and registration in the United States of America.

DISCLAIMER

SENSIDYNE, LP ASSUMES NO RESPONSIBILITY WHATSOEVER, TO ANY PARTY WHOSOEVER, FOR ANY PROPERTY DAMAGE, PERSONAL INJURY, OR DEATH CAUSED BY OR RESULTING FROM, IN WHOLE, OR IN PART, THE IMPROPER USE, INSTALLATION, OR STORAGE OF THIS PRODUCT BY THE USER, PERSON, FIRM, ENTITY, CORPORATION OR PARTY NOT ADHERING TO THE INSTRUCTIONS AND WARNINGS OR NOT ADHERING TO ALL FEDERAL, STATE, AND LOCAL ENVIRONMENTAL AND OCCUPATIONAL HEALTH AND SAFETY LAWS AND REGULATIONS. THE SELLER SHALL NOT BE LIABLE FOR DIRECT, INDIRECT, CONSEQUENTIAL, INCIDENTAL OR OTHER DAMAGES RESULTING FROM THE SALE AND USE OF ANY GOODS AND SELLER'S LIABILITY HEREUNDER SHALL BE LIMITED TO REPAIR OR REPLACEMENT OF ANY GOODS FOUND DEFECTIVE. THIS WARRANTY IS IN LIEU OF ALL OTHER WARRANTIES, EXPRESSED OR IMPLIED, INCLUDING BUT NOT LIMITED TO THE IMPLIED WARRANTIES OF MERCHANTABILITY AND FITNESS FOR USE OR FOR A PARTICULAR PURPOSE WHICH ARE EXPRESSLY DISCLAIMED.

WARNINGS**READ AND UNDERSTAND ALL WARNINGS BEFORE USE**

Read and understand ALL warnings before using this product. Failure to read, understand, and comply with ALL warnings could result in property damage, severe personal injury, or death.

Read and understand ALL applicable federal, state, and local environmental health and safety laws and regulations, including OSHA. Ensure complete compliance with ALL applicable laws and regulations before and during use of this product.

The user/installer must understand the Hazardous Area Protection Concepts and Area Classifications applicable to their operation.

UNDER NO CIRCUMSTANCES should this product be used except by qualified, trained, technically competent personnel and not until the warnings, User Manual, labels, and other literature accompanying this product have been read and understood.

Failure to read and understand the User Manual may result in preventable severe personal injury or death.

ALWAYS wash your hands thoroughly after handling, calibrating, or servicing this product.

ALWAYS wear eye protection (such as safety goggles), face shield, chemical resistant gloves and chemical resistant clothing when handling chemicals, or calibration sources.

DO NOT get chemicals, gases, fumes, or vapors in your eyes or on your skin, as they may cause severe burns to skin and eyes. If chemicals, gases, fumes, or vapors get in your eyes or on your skin, wash the affected area with copious amounts of water and call a physician immediately.

ALWAYS avoid any contact of acids with your skin or eyes. Seek immediate medical attention for any contact with acids.

ALWAYS calibrate in a well ventilated area. Adequate precautions should be taken to prevent the buildup of ANY calibration sources or vapors. Avoid breathing ANY calibration fumes or vapors as they may be hazardous to your health.

ALWAYS dispose of chemicals and calibration sources in compliance with ALL applicable safety laws, regulations, and guidelines for proper disposal. Failure to do so may result in environmental damage, property damage, personal injury or death.

ALWAYS close ALL containers of chemicals used with this product after use.

ALWAYS ensure that any compressed calibration substance sources are empty prior to disposal, should they be used.

ALWAYS use clean, dry, inert materials to contain and transfer substances used for calibration.

DO NOT remove, cover, or alter any label or tag on this product, its accessories, or related products.

DO NOT operate this product should it malfunction or require repair. Operation of a malfunctioning product, or a product requiring repair may result in serious personal injury or death.

DO NOT attempt to repair or modify instrument, except as specified in the Operation & Service Manual. If repair is needed, contact the Sensidyne Service Dept. to arrange for a Returned Material Authorization (RMA) (See Section 0 for details).

Users should refer to MSDS and suppliers' instructions for proper handling and safety instructions for any chemicals used with this equipment.

• INSTALLATION

Make certain you read and understand the Operation & Service Manual for your transmitter before installation the Aspirated Sample Draw Accessory.

Refer to all NEC and local electrical codes to ensure compliance for proper installation.

Overview

The Sensidyne, LP Sample Draw System is offered as an aspirated unit with an integral aspirator and a rotameter is provided for visual indication of flow. The aspirator is designed to operate at a supply pressure of 30-40 PSIG. NOTE: 40 PSI is Maximum allowable pressure. **Special care must be taken to insure the supply air is moisture and oil free.** Paint spray quality or instrument grade air is suggested for use. A fail-safe flow switch will de-actuate a relay and provide a signal on loss of flow or power failure. A 2-way valve permits the application of calibration standards to the gas sensor(s) for routine PMs. The sample system can be used with up to four gas sensors placed upstream of the aspirator unit so that the gas sensors operate near atmospheric pressure. The sample must be vented to a safe outdoor area.

The system is housed in a NEMA 4X Fiberglass enclosure which is de-rated to NEMA 3R due to the required fittings and appurtances. The sample draw is pending Factory Mutual Listing and approval for placement in a Class I, Division 2 Hazardous (Classified) Area, to sample from a Class I, Division 1 area. Gas Groups C and D are covered by the approval. A Division 2 approval has the distinct advantage of eliminating the need for flame arrestors in the sample tubing, which can be a significant maintenance item due to dirt and moisture.

The system Power supply is capable of operating the pump and up to two transmitters, or one with annunciation. This feature reduces user costs and broadens the scope of application.

Sample draw users are cautioned that while this is an excellent tool it must be applied carefully to avoid excessive maintenance. Sample conditioning, drying, heating or cooling may be required. Sampling from a warmer to a cooler environment will cause condensation in the sample line. Water removal via the optional coalescing filter on the sample inlet is necessary. A simple dust filter (by others) is recommended on the end of the tubing. PPM level acid gases are not compatible with the sample draw system as they disappear into the tubing and moisture during transit. Do not use the system for Cl₂, ClO₂, ETO, HCl, HCN, HF, NO₂, O₃, COCl₂ and SO₂. Flammable gases and vapors, Ammonia, CO, CO₂, H₂S and Oxygen are compatible and the most common application gases and vapors.

• MOUNTING SAMPLE DRAW UNIT

The unit should be mounted on a flat location. Mounting feet for the enclosure are provided. The sample draw unit is designed for placement in a Class I, Division 2 Hazardous (Classified) area to sample from a Class I, Division 1 area, groups C and D. Figure 5 shows actual dimensions.

• WIRING THE SAMPLE DRAW UNIT

Refer to Figure 1 and follow the steps below.

- 1) Get confirmation from the safety officer, or other appropriate person, that the area is safe and free of hazardous atmospheres.

CAUTION
Proper ESD procedures should be taken before touching any components inside the transmitter conduit.

- 2) Verify that the conduit seal fitting is properly installed between the transmitter and the sample draw conduit (if applicable).
- 3) Verify that all wires are not energized.

NOTE: Pull straight up when removing terminal block connectors. A 2 mm slotted screwdriver is required for wiring terminal blocks.

- 4) Units with power supply, part number 821-0232-01, TB2 is already connected. Connect the power supply to AC supply. Green wire Ground, White wire to N (neutral), Black wire to L (load).
 - a. If using an external 24Vdc control device or Battery Back-up to power up the sample draw unit, connect 24Vdc power to TB3 terminal.
 - b. For sample draw unit without power supply, unit part number 821-0232-02, connect 24Vdc power to TB2 terminal.

NOTE
Always refer to the NEC and local electrical codes to ensure compliance for proper installation.

- 5) Connect the positive wire from the +24 Vdc (positive) terminal on TB4 to +24 Vdc on transmitter board. **Refer to transmitter manual.**
- 6) If you are wiring a 3-wire transmitter, connect the negative terminal TB4 to the return on the transmitter.

NOTE
A filter is recommended to prevent dust contamination and water intrusion.

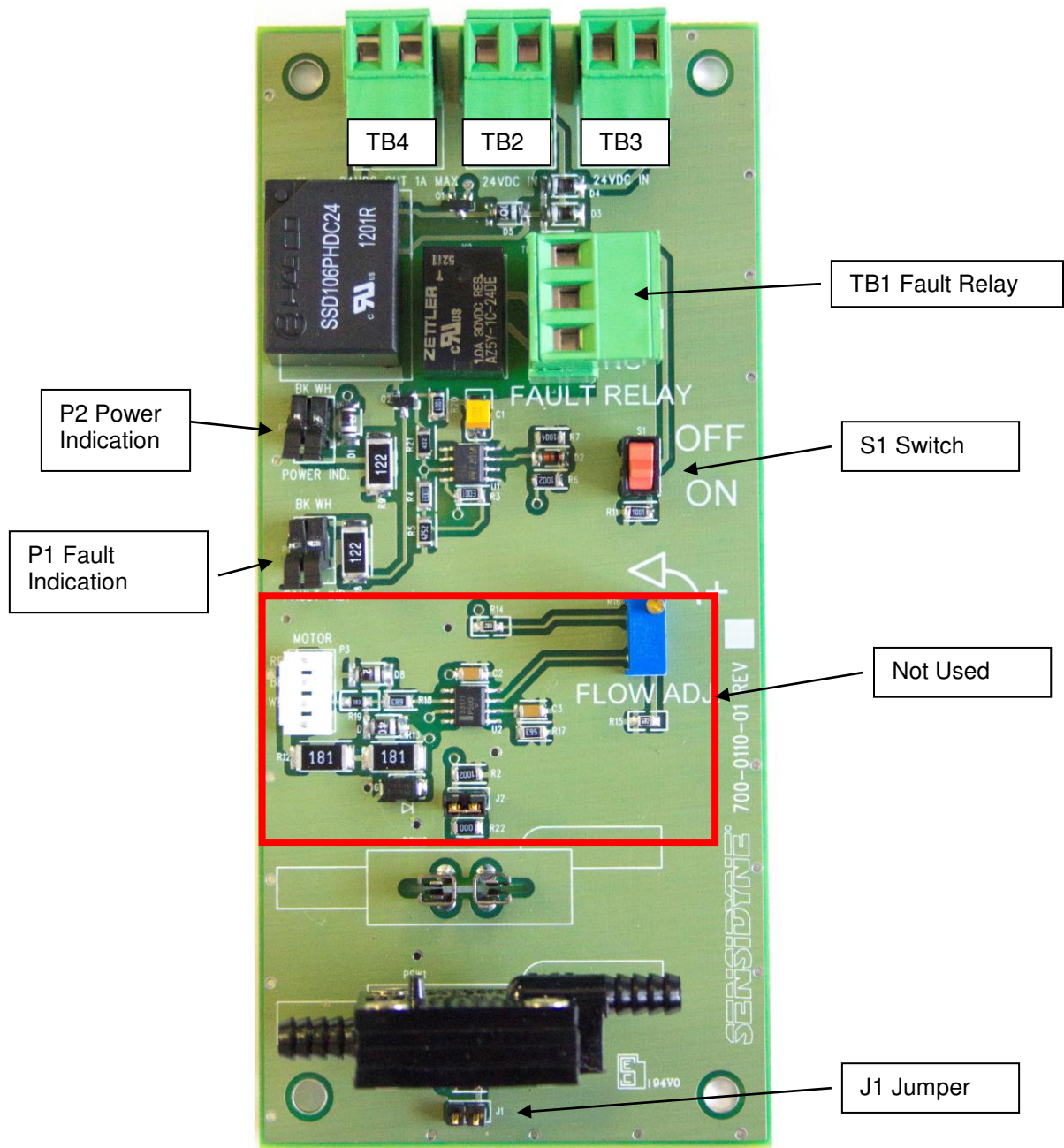

Figure 1
Board Layout

• ON / OFF SWITCH

NOTE: When the Sample Draw unit is first powered on, it is normal for there to be a flow fault indication for up to 20 seconds until flow is established.

Refer to Figure 1:

1) When S1 switch is in off position, there is no power to the sample draw board. TB2 and TB3 still passes to TB4. Fault indicator will not illuminate. TB1 (Fault Relay) will indicate fault.

• JUMPER J1:

Units are shipped from the factory without J1 jumper installed. When the jumper is not installed, the unit is in normal operation. With the jumper in place, the fault will not trigger. This simulates normal operation and bypasses the fault.

• WIRING THE FLOW FAULT ALARM RELAY

The preset trip point for the flow fault alarm setpoint is 300cc/min +/- 100cc/min. The flow fault alarm relay (TB1) is 1 Form C relay with the following specification: 1 amp @ 30 Vdc Max.

Wire the flow fault alarm relay as follows (see Figure 1):

- 1) Normal Operation
 - a. NO: Open
 - b. NC : Closed

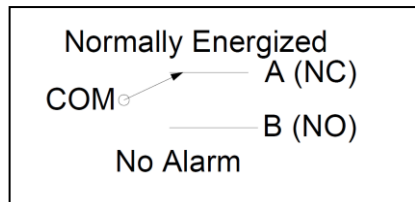

- 2) Fault Condition
 - a. NO: Closed
 - b. NC: Open

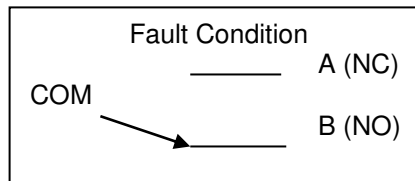

• POWER INDICATION

Refer to Figure 1:

1) P2 is On when Switch S1 is in the ON position and 24Vdc is present.

• FAULT INDICATION

Refer to Figure 1:

1) P1 is On when Switch S1 is in the ON position, 24Vdc is present and a Fault condition is present.

• ADJUSTING THE FLOW

1) Flow Control Valve controls the aspirator flow. Counter clockwise increases flow. Nominal flow is 1LPM.

• **CALIBRATION**

- 1) Please see transmitter manual for sensor calibration instructions. To calibrate the sensor you will need: calibration gas, regulator, and tubing. Tygon tubing is sufficient for non-reactive gases. For reactive gases, Teflon tubing must be used. Reactive gases include: HCl, Cl₂, HF, SO₂, ClO₂, NO₂ and ETO.
- 2) During Normal operation, the Cal Gas IN selector switch should be pointing towards the hinges of the sample draw box.
- 3) See Figure 2. For calibration, the Cal Gas IN selector switch must be turned 180degrees to the right. This diverts the gas flow to come from the calibration gas bottle instead of through the standard sample inlet. The flow fault alarm will be indicated as the gas flow is not going through the sample inlet.

• **FLOW BLOCK**

A flow block accessory part is required when connecting the transmitter/sensor unit to the sample inlet. For SensAlert Plus & SensAlert ASI transmitters, the Plus series flow block part number is 821-0202-01.

• **COALESCING INLET FILTER (Optional)**

An inlet filter on the sample draw accessory performs two functions. The filter removes most or all particulates with high efficiency thereby protecting the flow switches and the pump from particulate contamination.

As a secondary function, it acts to prevent the ingress of water into the switches and sensor. If water enters the filter in small quantities it is blocked and eventually evaporates and passes through the filter.

If a sufficient quantity accumulates it will block flow through the filter and cause a flow fault. Periodically the filter should be replaced to keep the pressure drop low. The interval will depend on the amount of particulate in the sample. If the filter clogs during operation it will cause a flow fault.

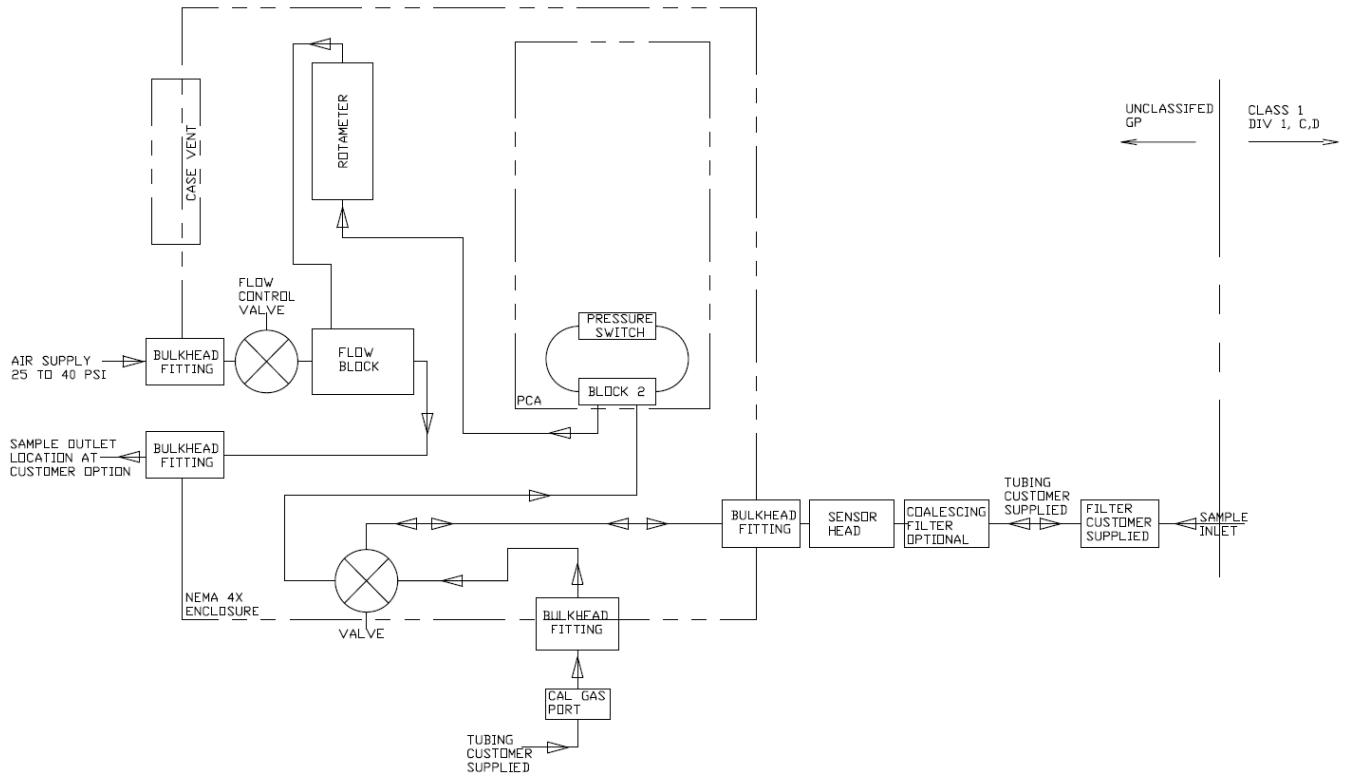
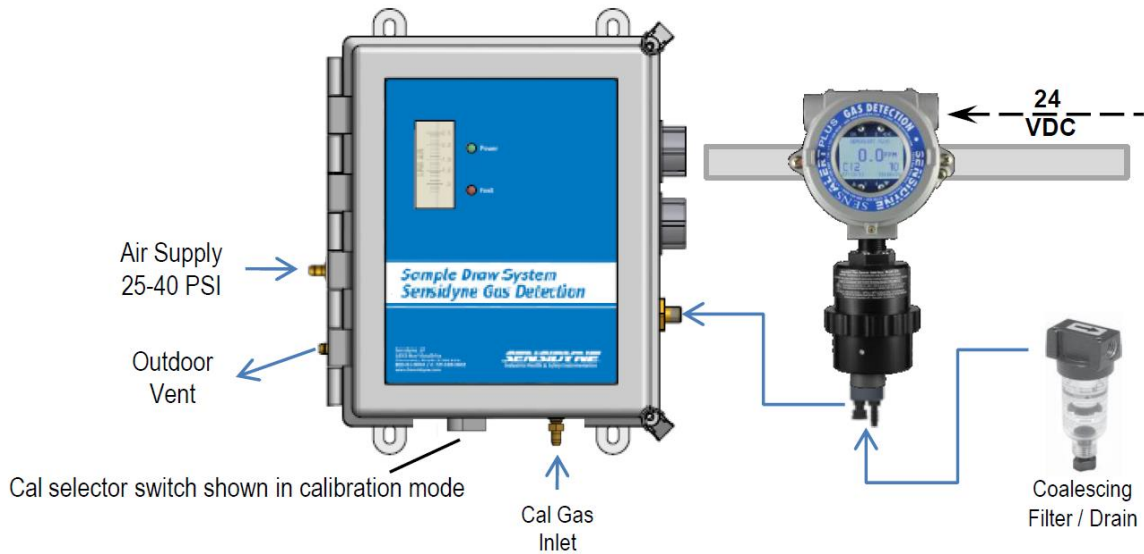

Figure 3

Class I, Division 2 or Non-hazardous Area



Note: The unit is FM approved for placement in a Class I, Division 2 hazardous (classified) area to sample from a Class I, Division 1 environment. Flame arrestors are not required or furnished. The flow fault relay is for customer wiring and use. In cold climates heat-tracing may be required to prevent condensation or freezing.

Figure 4 Example application

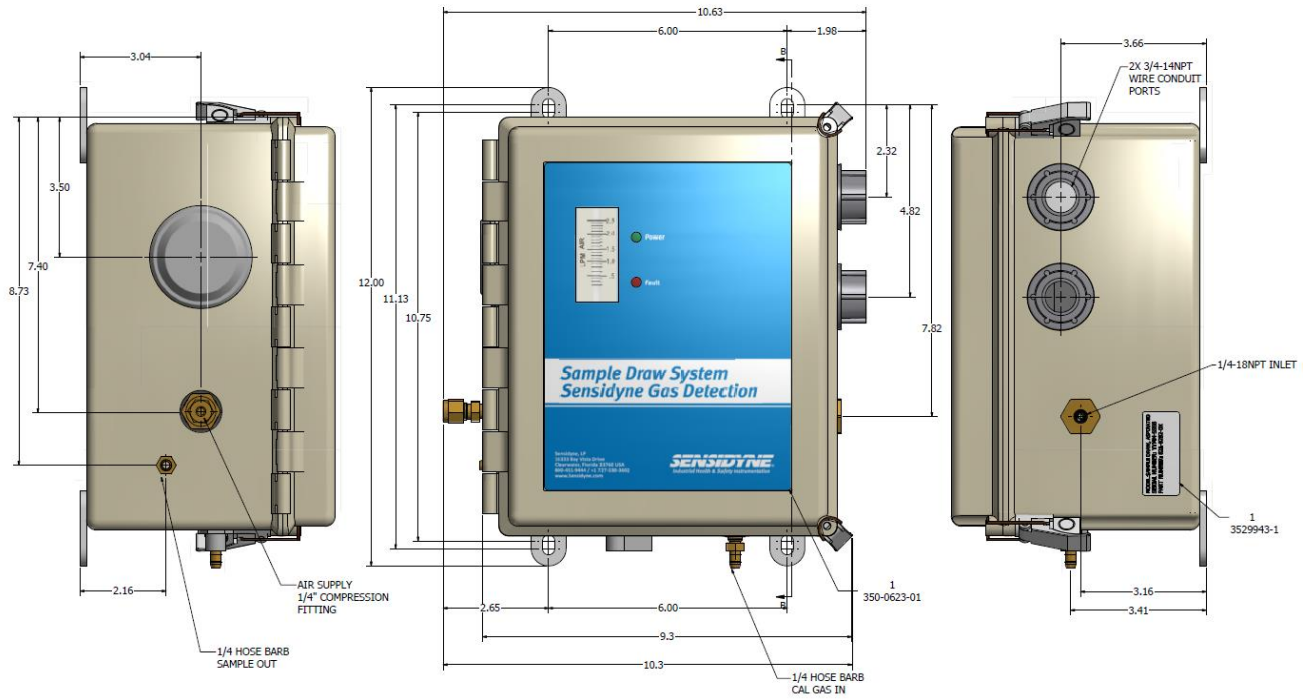

Figure 5 Dimensional Drawing

Specifications

General Specifications

Conduit	Female 3/4" NPT
Housing.....	Fiberglass, NEMA 3R
Dimensions	11" (H) X 10" (W) X 6.375" (D), 27.9cm X 25.4cm X 16.2cm
Weight.....	5.9 lbs (2.7 kg)
Sample Temperature Range	32-122°F (0° to 50°C), non-condensing
Temperature Range	0° to 122°F (-18° to 50°C)
Leak Specification	1 inch H ₂ O drop in 5 seconds at -25 inches H ₂ O
Tubing Connections.....	1/4 inch OD Compression Fitting - Supply Air, 1/4-18 NPT - Sample Inlet (Fitting Required), 1/4 inch ID Hose Barb - Sample Outlet, 1/4 inch ID Hose Barb - Calibration Gas
Aspirator Supply Pressure	30-40 PSIG
Nominal Flow Range	0.75 to 1.0 LPM @ -40 inches H ₂ O

Electrical Specifications

Flow Fault Alarm Setpoint	Preset Trip Point 300 cc/min +/- 100 cc/min
Flow Fault Relay.....	SPDT, Form C, 1 Amp, 30VDC Maximum
Power Input Requirements	Flow Fault Board: 18-30 VDC, 20 Watts
Power Input Requirements	AC Power Supply: 85-240 VAC, 47-63Hz.

Controls

Switch (S1)	Turning S1 to the on position energizes the sample draw circuit board and enables flow fault detection.
Flow Control Valve (FCV)	Turning FCV counterclockwise increases flow through the system. Turning FCV clockwise decreases flow through the system.
Jumper (J1).....	<u>Not</u> Installed: The unit is in normal operation and loss of flow or power will de-energize the flow fault relay. Installed: J1 simulates normal operation and bypasses the flow fault indication regardless of actual flow conditions.

Indicators

Power.....	Green LED: Illuminates when switch (S1) is turned to the "On" Position and 24VDC is present at the board power connector.
Fault.....	Red LED: Illuminates when power switch is turned to the on position, 24vdc is present at the board power connector and Flow Fault is present.

Spare Parts

Aspirator Unit	821-0234-01
Flow Block, Plus series	821-0202-01
Coalescing Filter + Close Nipple	821-0233-01

Complete Aspirated Sample Draw units

With power supply	820-0232-01
Without power supply	821-0232-02

Returned Material Authorization

Sensidyne maintains an instrument service facility at the factory to provide its customers with both warranty and non-warranty repair. Sensidyne assumes no liability for service performed by personnel other than authorized Sensidyne authorized personnel. To facilitate the repair process, please contact the Sensidyne Service Department in advance for assistance with a problem which cannot be remedied and/or requires the return of the product to the factory. All returned products require a Returned Material Authorization (RMA) number. Sensidyne Service Department personnel may be reached at:

Sensidyne, LP
1000 112th Circle N, Suite 100
St. Petersburg, FL 33716 USA
800-451-9444 • +1 727-530-3602
+1 727-538-0671 [Service Fax] email: info@sensidyne.com

All non-warranty repair orders will have a minimum fee assessed whether the repair is authorized or not. This fee includes handling, administration and technical expenses for inspecting the instrument and providing an estimate. However, the estimate fee is waived if the repair is authorized.

If you wish to set a limit to the authorized repair cost, state a "not to exceed" figure on your purchase order. Please indicate if a price quotation is required before authorization of the repair cost, understanding that this involves extra cost and handling delay. Sensidyne's repair policy is to perform all needed repairs to restore the instrument to its full operating condition.

Repairs are handled on a "first in - first out" basis. Your order may be expedited if you authorize an expediting fee. This will place your order next in line behind orders currently in process.

Pack the instrument and its accessories (preferably in their original packing) and enclose your return address, purchase order, shipping and billing information, RMA number, a description of the problem encountered with your instrument and any special instructions. All prices are subject to change without notice.

If this is the first time you are dealing directly with the factory, you will be asked to prepay or to authorize a COD shipment.

Send the instrument, prepaid, to:

SENSIDYNE
1000 112th CIRCLE N, SUITE 100
ST. PETERSBURG, FL 33716 USA
ATTENTION: Service Department
RMA #: _____

SERVICE OPTIONS

The Sensidyne Service Department offers a variety of service options which will minimize costly interruptions and maintenance costs. These options include initial training, on-site technical assistance, and full factory repairs. Sensidyne has developed several programs which offer options best suited to your applications and needs. For further information, contact the Sensidyne Service Department at the following numbers: 800-451-9444 • +1 727-530-3602 • +1 727-538-0671 [Service Fax].

Manufactured by:

Sensidyne, LP
1000 112th Circle N, Suite 100
St. Petersburg, Florida 33716
USA

800-451-9444 • 727-530-3602 • 727-539-0550 [fax]
www.Sensidyne.com • info@sensidyne.com

Authorized EU Representative

Schauenburg Electronic Technologies GmbH
Weseler Str. 35 · 45478
Mülheim-Ruhr Germany

+49 (0) 208 9 99 10 • +49 (0) 208 5 41 10 [fax]
www.schauenburg.com • international@schauenburg.com

SENSIDYNE[®]

Sensidyne, LP
1000 112th Circle N, Suite 100
St. Petersburg, Florida 33716 USA
Tel: 800-451-9444 / +1 727-530-3602 • **Fax:** +1 727-539-0555
web: www.Sensidyne.com • www.SensidyneGasDetection.com
e-mail: info@Sensidyne.com