

SENSIDYNE®

Industrial Health & Safety Instrumentation

INSTRUCTION MANUAL

SENSCAST WIRELESS MONITORING SYSTEMS (With RF Wireless Interface)

Document No. 360-0197-01 • Revision A



[SENSICAST Monitors](#)

[SENSICAST Receiver](#)







Warning: Read & understand contents of this manual prior to operation. Failure to do so could result in serious injury or death.

Users are responsible for correct translations of this manual into their native language

1000 112th Circle N. Suite 100 • St. Petersburg, Florida 33716

800-451-9444 • 727-530-3602 • Fax: 727-539-0550

Web: www.Sensidyne.com • e-mail: info@sensidyne.com

Chapter 1 – SAFETY INFORMATION.....	1
1.1 SAFETY INFORMATION – READ BEFORE INSTALLATION & APPLYING POWER	1
1.2 CONTACTING SENSIDYNE LP.....	1
Chapter 2 – GENERAL DESCRIPTION	2
2.1 INTRODUCTION	2
2.2 DESCRIPTION OF SENSICAST CLIENT / SERVER WIRELESS NETWORKS.....	2
SENSICAST MONITOR	4
Chapter 3 – SENSICAST MONITOR DESCRIPTION	4
3.1 SENSICAST MONITOR LCD READOUTS	4
3.1.1 SENSICAST MONITOR LCD STATUS ICONS – ZZZ, SNIFF, RNG,  ,  ,  , 	4
3.2 SENSICAST RF BROADCAST CYCLE AND CONSERVING BATTERY LIFE	5
3.3 SENSICAST TRANSMITTER 299-0084-01 BATTERY / I/O PCB	6
3.4 SENSICAST TRANSMITTER 299-0082-01 DISPLAY / RADIO PCB	6
Chapter 4 - SENSICAST MONITOR INSTALLATION INSTRUCTIONS	8
4.1 RATINGS AND CERTIFICATIONS	8
4.2 SENSOR LOCATION	8
4.3 MOUNTING THE ENCLOSURE	8
4.3.1 SENSICAST TRANSMITTER 299-0072-01 MAGNETIC MOUNT OPTION.....	8
4.4 SPECIFICATIONS.....	10
4.4.1 POWER SUPPLY	10
4.4.2 POWER CONSUMPTION.....	10
4.4.3 MAXIMUM TRANSMIT (TX) POWER	10
4.4.4 RECEIVE (RX) SENSITIVITY	11
4.4.5 RADIO FREQUENCY.....	11
4.4.6 MEMORY:	11
4.5 ANTENNA TRANSMISSION RANGE.....	11
4.5.1 ANTENNA SELECTION & LOCATION	12
4.5.2 WATER PROOFING ANTENNA CONNECTIONS.....	12
4.5.3 SYSTEM GROUNDING	13
Chapter 5 – SENSICAST MONITOR ROUTINE OPERATING INSTRUCTIONS	14
5.1 USING THE MAGNETIC KEYPAD	14
5.2 CYCLING SENSICAST TRANSMITTER POWER ON/OFF	14
5.3 CAL MODE – ROUTINE CALIBRATIONS	14
5.4 ALARM OPERATION	16
5.4.1 UNDERSTANDING FAIL ALARM OPERATION	16
5.4.2 LOW BATTERY CONDITION	16
5.5 SMART SENSOR MODULES	17
5.5.1 SENSICAST TRANSMITTER 299-0091-01 SENSOR SEPARATION KIT	17
Chapter 6 – SENSICAST MONITOR SETUP MENUS.....	19
6.1 MENU STRUCTURES	19
6.2 MAIN MENU	19
Chapter 7 – SENSICAST MONITOR CHANNEL SETUP MENUS	21
7.1 CHANNEL ENABLE / INACTIVE	21
7.2 CONFIGURE READOUT	21
7.2.1 MEASUREMENT NAME.....	21
7.2.2 EUNIT.....	21
7.2.3 ZERO (0%)	22
7.2.4 SPAN (100%)	22
7.2.5 DECIMAL POINTS.....	22
7.2.6 CAL SPAN VAL	22
7.2.7 READOUT DEAD BAND.....	22
7.2.8 TRACK NEGATIVE.....	22
7.2.9 BACKUP CONFIG.....	22
7.2.10 RESTORE CONFIG.....	22

7.2.11	LOAD DEFAULTS	22
7.3	ALARM SETTINGS.....	23
7.3.1	SET POINT	23
7.3.2	DEAD BAND.....	23
7.3.3	LOW TRIP	23
7.4	SENSOR INFORMATION.....	23
7.5	TECHNICIANS ONLY.....	24
7.5.1	SET GAIN TO UNITY (TECHNICIANS ONLY!)	25
7.5.2	PREAMP GAIN ADJUST (PGA) (TECHNICIANS ONLY!)	25
7.5.3	ZERO CAL VALUE (TECHNICIANS ONLY!)	26
7.5.4	RAW MIN / MAX COUNTS (TECHNICIANS ONLY!)	26
7.5.5	RF LINK TEST (TECHNICIANS ONLY!)	26
7.5.6	SENSOR TEMP COMP TABLE (TECHNICIANS ONLY!)	26
7.6	PACKET COUNT	27
7.7	SENSOR TEMP READING.....	27
Chapter 8 – SENSCAST MONITOR DEVICE SETUP MENUS.....		28
8.1	RF LINK SETUP	28
8.1.1	NETWORK ID	28
8.1.2	RMTID.....	29
8.1.3	*WAKEUP TIMER.....	29
8.1.4	*TX RETRIES	29
8.1.5	*TX CONFIG TIME	29
8.1.6	RF LINK STATUS.....	30
8.1.7	*RF HANDSHAKING (900MHZ MODELS ONLY).....	30
8.1.8	*RF LINK.....	30
8.1.9	*TX POWER (900MHZ MODELS ONLY).....	30
8.1.10	TX CNT (TRANSMIT COUNTER).....	31
8.2	CLOCK, WARM-UP and CAL PURGE DELAYS	31
8.2.1	WARM UP TIMER	31
8.2.2	CAL PURGE TIMER	31
8.3	SYSTEM SECURITY.....	31
8.4	LCD CONTRAST ADJUST.....	32
8.5	TURN POWER OFF.....	32
8.6	RESET RANGE ICON	33
SENSCAST RECEIVER		34
Chapter 9 - SENSCAST RECEIVER DESCRIPTION		34
9.1	SENSCAST RECEIVER DESCRIPTION	34
9.2	DATA DISPLAY SCREENS	36
9.2.1	EUNIT/BAR GRAPH SCREEN AND COMM ERROR TIME LINE.....	36
9.2.2	ALARMS STATUS CLEAR SCREEN.....	37
9.2.3	CHANNEL ALARM STATUS SCREEN	37
9.2.4	EVENT LOG SCREEN	37
9.3	SPECIFICATIONS.....	38
9.3.1	POWER SUPPLY REQUIREMENTS	38
9.3.2	RELAYS.....	39
9.3.3	AMBIENT TEMPERATURE RANGE.....	39
9.3.4	HUMIDITY RANGE	39
9.3.5	ALTITUDE	39
9.3.6	HOUSINGS / INSTALLATION CATEGORIES.....	39
9.3.7	APPROVALS (PENDING)	39
Chapter 10 – SENSCAST RECEIVER OPERATION.....		40
10.1	OPERATOR INTERFACE	40
10.2	SETUP MENU CONFIGURATION	40
10.3	CHANGING MENU VARIABLES USING THE KEYPAD	41

10.4	SENSCAST RELAYER MAIN MENU	42
10.5	CHANNEL CONFIG MENU GROUP	42
10.5.1	CHANNEL ACTIVE.....	42
10.5.2	REMOTE ADDRESS.....	42
10.5.3	CHANNEL INFO	43
10.5.4	RX PACKETS.....	43
10.5.5	BATT 3.6V.....	43
10.6	SYSTEM CONFIG MENUS	43
10.6.1	CONFIGURE RELAYS.....	43
10.6.2	PIEZO FUNCTION	44
10.6.3	TIME/DATE SETUP	45
10.6.4	TOTAL CHANNELS.....	45
10.6.5	RELAY REFRESH	45
10.6.6	PIEZO REFRESH.....	45
10.6.7	LOCAL PIEZO.....	45
10.7	COMMUNICATIONS	45
10.7.1	SENSCAST RADIO	46
10.7.2	RX HISTORY	47
10.8	SECURITY	47
10.9	DATA/EVENT LOG	47
10.9.1	EVENT LOG	47
10.9.2	DATA LOG(OPTIONAL)	48
10.10	TECHNICIANS ONLY.....	49
Chapter 11	– SENSCAST RECEIVER PCBs	50
11.1	MOTHERBOARD INTERFACE PCB # 299-0067-01	50
11.2	RELAY PCB # 299-0068-01.....	52
11.3	OPTIONAL 24VDC 50 WATT POWER SUPPLIES # 299-0044-01.....	52
Chapter 12	– SENSCAST RECEIVER ENCLOSURE OPTIONS.....	54
12.1	SENSCAST RELAYER/PY NEMA 4X POLYESTER WALL MOUNT	54
12.2	SENSCAST RELAYER/PCS NEMA 4 PAINTED CARBON STEEL WALL MOUNT	55
12.3	SENSCAST RELAYER/SS NEMA 4X STAINLESS STEEL WALL MOUNT	55
12.4	SENSCAST RELAYER/XP NEMA 7 EXPLOSION-PROOF WALL MOUNT	56
Chapter 13	– 299-0085-01 SENSCAST RECEIVER MULTI-FUNCTION OPTION	58
13.1	MODBUS COMMUNICATIONS MENU	59
13.1.1	MODBUS REGISTER SUMMARY.....	59
13.2	WIRELESS MODBUS OPTION	65
13.2.1	WIRELESS MODBUS SLAVE MODE	65
13.3	WIFI COMMUNICATIONS OPTION.....	65
13.3.1	SENSCAST RECEIVER WIFI MENUS	65
13.3.2	WEBPAGE MENUS	66
13.4	DATA LOGGING AND USB OPTION	72
13.4.1	DATA LOGGING FILE STRUCTURE.....	72
13.4.2	SENSCAST RECEIVER DATA LOGGING MENUS	72
13.4.3	WEBPAGE DATA LOGGING MENUS	72
SENSCAST RELAYER		74
Chapter 14	– SENSCAST RELAYER DESCRIPTION	74
14.1	SENSCAST RELAYER DESCRIPTION.....	74
14.2	SENSCAST RELAYER MENUS.....	74
14.2.1	MAIN MENU.....	76
14.2.2	CHANNEL CONFIG MENU GROUP.....	76
14.2.3	SYSTEM CONFIG MENU GROUP.....	77
14.2.4	COMMUNICATIONS	79
14.2.5	SECURITY	80
14.2.6	TECHNICIANS ONLY.....	80

14.3	SENSCAST RELAYER PCBS.....	81
14.3.1	SENSCAST RELAYER 299-0083-01 DISPLAY / RADIO PCB.....	81
14.3.2	SENSCAST RELAYER 299-0092-01 POWER SUPPLY/RELAY PCB.....	82
Chapter 15	– SENSCAST RELAYER INSTALLATION INSTRUCTIONS.....	84
15.1	RATINGS AND CERTIFICATIONS.....	84
15.2	MOUNTING THE ENCLOSURE.....	84
15.2.1	SENSCAST TRANSMITTER 299-0072-01 MAGNETIC MOUNT OPTION.....	84
15.3	SPECIFICATIONS.....	86
15.3.1	POWER SUPPLY.....	86
15.3.2	POWER CONSUMPTION.....	86
15.3.3	MAXIMUM TRANSMIT (TX) POWER.....	86
15.3.4	RECEIVE (RX) SENSITIVITY.....	87
15.3.5	RADIO FREQUENCY.....	87
15.3.6	MEMORY.....	87
15.4	ANTENNA TRANSMISSION RANGE.....	87
15.4.1	ANTENNA SELECTION AND LOCATION.....	87
15.4.2	WATER PROOFING ANTENNA CONNECTIONS.....	88
15.4.3	SYSTEM GROUNDING.....	88
Chapter 16	– SENSCAST ANTENNA SELECTION.....	89
16.1	ANTENNA SELECTION.....	89
16.1.1	DIPOLE AND COLLINEAR ANTENNAS.....	89
16.1.2	YAGI ANTENNAS.....	89
16.1.3	MOUNTING NEAR OTHER ANTENNAS.....	90
16.1.4	COAX CABLES.....	90
16.2	SURGE PROTECTION & GROUNDING.....	90
16.2.1	ANTENNA GROUNDING.....	90
16.2.2	CONNECTIONS TO OTHER EQUIPMENT.....	91
Chapter 17	- SENSCAST LEGACY MODE.....	92
Chapter 18	- TABLE OF FIGURES.....	93

Chapter 1 – SAFETY INFORMATION

1.1 SAFETY INFORMATION – READ BEFORE INSTALLATION & APPLYING POWER

IMPORTANT

The SensCast Wireless Monitoring system described in this manual consists of anywhere from 1 to 32 SensCast Monitors wirelessly sending data to any number of SensCast Receivers and/or SensCast Relays. Users should have a detailed understanding of SensCast operating and maintenance procedures. Use the SensCast system only as specified in this manual, or detection of gases and the resulting protection provided may be impaired. Read the following **WARNINGS** prior to use:

WARNINGS

- Calibrate SENSCAST TRANSMITTER gas monitors that communicate to the SensCast with a known value at start-up and check calibration on a regular schedule, at least every 90 days. More frequent inspections are encouraged to spot problems such as dirt, oil, paint, grease or other foreign materials on the sensor head.
- Do not paint the sensor assembly or any part of the SENSCAST TRANSMITTER.
- Do not use the SensCast if any enclosure is damaged or cracked or has missing components.
- Make sure covers, internal PCBs and antenna connections are securely in place before operation.
- Use only a sensor assembly compatible with the SENSCAST TRANSMITTER and approved for the monitor.
- Periodically test for correct operation of the system's alarm events by exposing the monitor to a known value above the High Alarm set-point.
- Do not expose SensCast devices to electrical shock or continuous severe mechanical shock.
- Protect SensCast devices from dripping liquids and high power sprays.
- Use only for applications described within this manual.

CAUTION: FOR SAFETY REASONS THIS EQUIPMENT MUST BE OPERATED AND SERVICED BY QUALIFIED PERSONNEL ONLY. READ AND UNDERSTAND INSTRUCTION MANUAL COMPLETELY BEFORE OPERATING OR SERVICING.

WARNING - EXPLOSION HAZARD

**SUBSTITUTION OF COMPONENTS MAY IMPAIR SUITABILITY FOR CLASS I, DIVISION 2;
BATTERIES MUST ONLY BE CHANGED IN AN AREA KNOWN TO BE NON-HAZARDOUS.**

1.2 CONTACTING SENSIDYNE LP

To contact Sensidyne, L.P. call, fax, email or write:

1000 112th Circle N. Suite 100 • St. Petersburg, Florida 33716
800-451-9444 • 727-530-3602 • Fax: 727-539-0550
Web: www.Sensidyne.com • e-mail: info@sensidyne.com

Chapter 2 – GENERAL DESCRIPTION

2.1 INTRODUCTION

Sensidyne, LP SensCast is a Frequency Hopping Spread Spectrum (FHSS) **Client/Server** wireless monitoring system offered with integral 900 MHz or 2.4 GHz radio modules. Each SensCast system may have between 1-32 battery-powered SensCast Monitors, which are always “**Clients**”. SENSICAST TRANSMITTERs may be equipped with single or dual gas sensors and transmit two of the 32 maximum channel values to the SensCast Receiver and/or SensCast Relay. There must also be at least one SensCast Receiver configured as the network’s “**Server**”. Since it is often desirable to indicate readings and alarms in more than one location, multiple SENSICAST RELAYERs configured as “**Clients**” are easily added to the same wireless network, but only one may be configured as the “**Server**”. SensCast radio configuration allows up to 26 separate FHSS hopping patterns and therefore as many as 26 separate SensCast systems may be collocated into the same area. Each network’s Server transmits Hopping Pattern and System ID settings only to Clients assigned to its network.

900MHz model’s transmit power is adjustable between 10mW and 1W (0-30dBm EIRP; 2dBi gain antenna) and 2.4GHz model’s power is fixed at 125mW (21dBm; conducted).

SENSICAST TRANSMITTERs are low power devices powered by an integral lithium D cell battery. SENSICAST RELAYERs must be continuously powered by an external power source (85-240VAC or 10-30VDC) and are ideally suited for 12VDC solar power supplies.

Additional features include:

- On screen radio status icons indicate “Server In-Range”, “Server Out-of-Range”, “Server Previously Out-of-Range” and “Low Battery” conditions.
- No potentiometer or jumper settings required. Cycling of power and configuration is with menus accessed via the LCD / magnetic keypad operator interface without opening the enclosure.
- “Smart Sensor” technology keeps gas type, range, calibration, temperature compensation and other sensor related parameters on the sensor module.
- If a sensor must be replaced, new smart sensors are recognized by the SENSICAST TRANSMITTER and prompts users to either upload new configuration data or continue with data from the previous smart sensor.
- Missing sensors trip the FAIL alarm.
- Smart sensors are industry proven for fast response and long life.
- Field adjustable alarm levels flash front panel LED indicators for HIGH, WARN, FAIL conditions. Alarm relays are not available on the SENSICAST TRANSMITTERs with this low power model, but SENSICAST CONTROLLERs come equipped with 8 programmable relays and SENSICAST RELAYERs come equipped with four programmable relays.
- CAL MODE provides on-screen prompts when to apply calibration gas during calibrations.
- “Sensor life” bar-graph updates after each SPAN calibration indicating when to replace old sensors.
- One hour trend screen shows rate of change of gas exposures.
- Modular design affords efficient installation and plug in sensors allow changing target gases even after installation.

2.2 DESCRIPTION OF SENSICAST CLIENT / SERVER WIRELESS NETWORKS

All Sensidyne, LP wireless devices utilize a FHSS (Frequency Hopping Spread Spectrum) Client / Server network where multiple **Clients** synchronize their frequency hopping to a single **Server**. Each network’s **Server** transmits a beacon at the beginning of every frequency hop. **Clients** with the same **Hop Channel** and **System ID** menu settings listen for the **Server’s** beacon and upon receiving it, synchronize their hopping with the **Server**. SENSICAST CONTROLLER may be user configured as either **Clients** or **Servers** since many installations require more than one SENSICAST CONTROLLER, but only one Server is allowed per network. Battery powered SENSICAST TRANSMITTER are always **Clients** because their radio is usually powered down and therefore unable to continuously broadcast

beacons as required by the **Server**. When there are multiple SENSICAST CONTROLLER's on the same network, the most centrally located is usually designated as the Server. Multiple SENSICAST RELAYERs may be added to any SensCast system in order to provide additional alarms, and/or function as repeaters for the alarm states of the SENSICAST TRANSMITTERs in the SensCast network.

Each device on a SensCast network must have its **NETWORK ID** menus configured to share the same **Hop Channel** and **Systems ID**. To simplify this setup, SENSICAST TRANSMITTERs, SENSICAST CONTROLLERs and SENSICAST RELAYERs are limited to 26 unique **Hop Channel** and **System ID** settings entered as "A" through "Z" in the **NETWORK ID** menu. All devices must have the same **Network ID** letter designated to communicate with each other (see [Section 8.1.1](#)). This also means it is possible to collocate multiple FHSS networks within the same coverage area without interference.

IMPORTANT! There should never be two servers with the same network settings within the same coverage area because interference between the two servers will severely hinder RF communication!

Correct planning and design of wireless systems are imperative for ensuring a successful installation.

SENSCAST MONITOR

Chapter 3 – SENSICAST MONITOR DESCRIPTION

WARNING - EXPLOSION HAZARD

SUBSTITUTION OF COMPONENTS MAY IMPAIR SUITABILITY FOR CLASS I, DIVISION 2;
BATTERIES MUST ONLY BE CHANGED IN AN AREA KNOWN TO BE NON-HAZARDOUS.





3.1 SENSICAST MONITOR LCD READOUTS

Figure 3-1 shows the primary data display screens for displaying sensor readings, radio status and current alarm conditions. The Single Channel **Engineering Unit** and **One-Hour Trend** screens on the left side of Figure 3-1 are available even if the SensCast Monitor is equipped with Dual Sensors but there is two of each. The **Engineering Unit(Eunits)** screen has a large digital value with Eunits, a bar graph with Alarm 1, Alarm 2 and Alarm 3 levels indicated across the bar and a 16 character Measurement Name field for user ID of this measurement location. The NEXT key toggles to the **One-Hour Trend** screen which indicates the alarms levels horizontally across the screen and trends the most recent one hour of readings. The right screen shows the **Dual Monitor** readout available only when two smart sensors are enabled. Single Channel screens are also available in the Dual mode which totals 5 data displays for dual channel units.

3.1.1 SENSICAST MONITOR LCD STATUS ICONS – ZZ, SNIFF, RNG, , ,

The upper left LCD corner displays current status of the SENSICAST TRANSMITTER, and provides an indication of general health of the wireless network over time. These status icons and the COM LED are useful tools for evaluating RF communication and the current state of the SENSICAST TRANSMITTER.

The ZZ icon indicates the sensor is asleep and saving power. Every six seconds it awakes, reads the gas sensor's signal, and updates the displayed gas value. This is called a "sniff" and is indicated by the SNIFF icon, which flashes on the screen every 6 seconds. Following a sniff, if conditions described in [Section 3.2](#) have been met, the SENSICAST TRANSMITTER will wake up the radio and broadcast gas value and alarms over the airwaves to the SensCast Receiver and/or SensCast Relayer. The sniff icon may be replaced by other status icons to indicate problems as described below:

-  - **Server Out-of-Range** icon appears if the server's beacon was not received at the most recent attempt to broadcast.
- The RNG icon appears briefly at the beginning of each broadcast attempt to indicate the radio is awaiting the Server's beacon. If the beacon is not received after a few seconds the broadcast is terminated unsuccessfully and the  icon is displayed at each sniff instead of the sniff icon. If a subsequent attempt receives the beacon and broadcasts successfully, the  - **Server Previously Out-of-Range** icon will appear.
- The  (Server Previously Out of Range) icon is very useful in determining if intermittent communication failures are a result of this SENSICAST TRANSMITTER having problems receiving the Server's beacon as opposed to the SENSICAST CONTROLLER not receiving the SENSICAST TRANSMITTER broadcast packet. The duration and frequency of "out-of-range" conditions are stored in the SENSICAST CONTROLLER Event Log table described in [Section 10.9](#).
- When the 3.6 volt lithium battery is near end of life the  - **Low Battery** icon is displayed during sniffs.

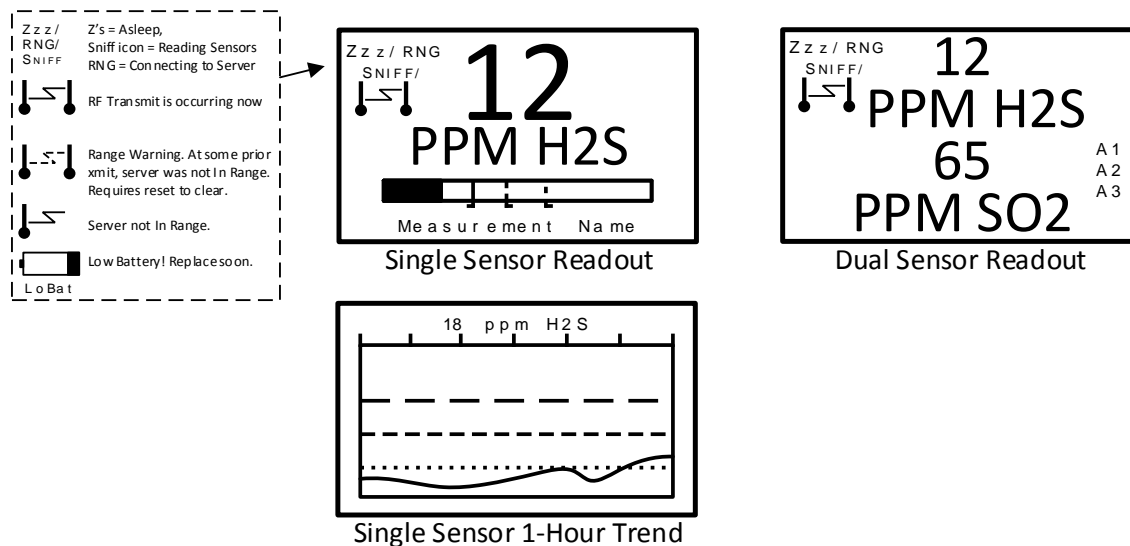





Figure 3-1 Readout Screen

3.2 SENSICAST RF BROADCAST CYCLE AND CONSERVING BATTERY LIFE

Most SENSICAST TRANSMITTER battery power is consumed as the radio communicates to the wireless network. Each Broadcast cycle consists of the following operations: Power up the radio; listen for the Server’s beacon; synchronize to the Server’s hopping pattern to become “In Range ”, transmit data packet out of the antenna and return to sleep mode. This sequence takes from .25 to 1 second to complete. If the SENSICAST TRANSMITTER radio fails to synchronize hopping with the Server upon the initial attempt it waits 6 seconds and tries again, then waits 6 seconds and tries once more. If the third attempt fails an “Out of Range ” icon is displayed and the SENSICAST TRANSMITTER goes to sleep and the scheduled Broadcast cycle repeats. Transmit power levels are adjustable (900MHZ models only) and the lower the power setting the longer the battery will last (see [Section 4.4](#)).

Every 6 seconds, the monitor performs a “sniff test” to detect level of target gas present at the sensor. At each “sniff test”, the **Zzz**’s “Sleep Mode” icon is briefly replaced by a status icon as described above in [Section 3.1.1](#). At this time, the LCD readout updates to indicate gas value measured during the sniff test. The radio stays OFF and no Broadcast occurs unless the gas value trips A1, A2 or A3 alarms, the **Wakeup Timer** expires (maximum of 5-minutes) or the conditions shown below are met. The following list identifies each of the conditions that cause the SENSICAST TRANSMITTER radio to Broadcast over the airwaves:

- A Broadcast occurs every time the **Wakeup Timer** menu expires (see [Section 8.1.3](#)). This is important since the SENSICAST CONTROLLER reports “Comm Error” for channels when no data is received after [**Wakeup Timer X 5**]. For example, if the SENSICAST TRANSMITTER **Wakeup Timer** is set to broadcast every 5 minutes, the SENSICAST CONTROLLER will indicate a Comm Error alarm for this channel if data is not received after approximately 25 minutes.
- Broadcasts occur after each 6 second sniff test if there is an A1, A2 or A3 alarm. “FAIL” alarms do not increase radio broadcast rates.
- A Broadcast occurs upon entry into CAL MODE, upon entry into CAL PURGE and again upon completion of the CAL PURGE. A status bit in the broadcast packet advises Receivers (SENSICAST CONTROLLER) and SensCast Relayers (RELAYER) this SENSICAST TRANSMITTER channel is being calibrated and alarms are inhibited. NOTE: Oxygen sensors cause 20.9% SENSICAST CONTROLLER readings during CAL MODE while all others cause zero readings (see CAL MODE [Section 5.3](#)).

- A Broadcast occurs if the reading rises or falls by >2% of full scale since the most recent Broadcast. This is to ensure a live reading at the SENSCAST CONTROLLER and/or SENSCAST RELAYER even though the **Wakeup Timer** might be set for a longer interval (5 minutes max).
- A Broadcast may be forced manually by holding the UP key for several seconds until the  icon appears then RELEASING THE UP KEY.
- A Broadcast occurs at the end of a Warm Up interval (see [Section 8.2.1](#)).
- A Broadcast occurs as menu items are edited and again upon returning the LCD to the readings display.

3.3 SENSCAST TRANSMITTER 299-0084-01 BATTERY / I/O PCB

SENSCAST TRANSMITTER electronics consist of the lower 299-0084-01 Battery / I/O PCB shown in Figure 3-2, connected by a cable to the upper 299-0082-01 Display / Radio PCB shown in Figure 3-3. 3.6 volt lithium 'D' cell battery will continuously power the unit for up to one year and may be replaced by following the procedure in Figure 3-2.

Connectors S1 and S2 are for connecting 299-0069-01 Sensor Heads directly to the 299-0084-01 Battery / I/O PCB. Terminal blocks TB1 and TB2 are for connecting to the 299-0091-01 "Sensor Separation Kit" with a 15' data cable (see [Section 5.5.1](#)).

IMPORTANT: Do not turn Power ON to the SENSCAST TRANSMITTER until the controller designated as Server is fully operational and ready to communicate to the SENSCAST TRANSMITTERs. Battery life is reduced if the SENSCAST TRANSMITTER is on for long periods while unable to communicate to the Server.

IMPORTANT: DO NOT ATTEMPT TO CHARGE THIS BATTERY OR REPLACE WITH ANY OTHER THAN PART # 10-2465 FROM Sensidyne, L.P.

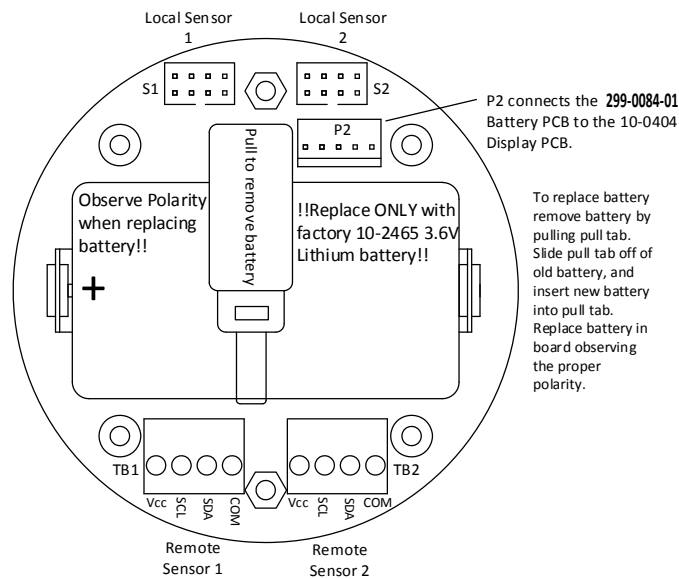

Figure 3-2 299-0084-01 Battery / I/O PCB

3.4 SENSCAST TRANSMITTER 299-0082-01 DISPLAY / RADIO PCB

SensCast systems support both 900MHz and 2.4GHz FHSS networks determined by the radio module mounted to the 299-0082-01 Display / Radio PCB. The 299-0041-01 900 MHz radio module mounts to the back of the 299-

0082-01 Display assembly as shown in Figure 3-3. Its MMCX RF connector attaches to the coax pigtail of the 299-0079-01 antenna fitting required for 900 MHz models.

The 299-0051-01 2.4GHz radio module also mounts to the back of the 299-0082-01 Display assembly as shown in Figure 3-3. Its u.FL RF connector attaches to the coax pigtail of the 299-0080-01 antenna fitting required for 2.4 GHz models.

A slender 5 conductor cable connects between the 299-0082-01 and the 299-0084-01 Battery / I/O PCB bolted to the bottom of the enclosure.

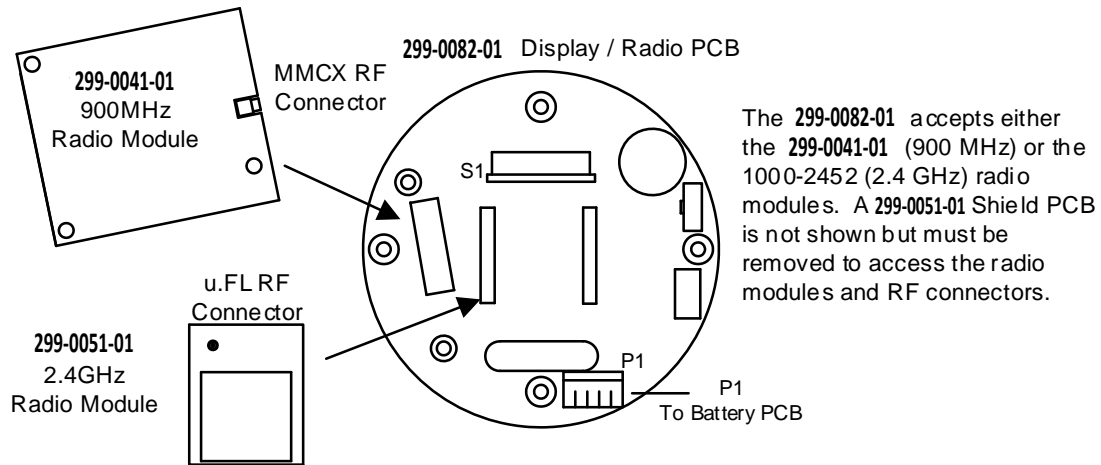

Figure 3-3 299-0082-01 Display / Radio PCB

Chapter 4 - SENSCAST MONITOR INSTALLATION INSTRUCTIONS

4.1 RATINGS AND CERTIFICATIONS

The enclosure is NRTL certified for Division 1 hazardous area installations for explosion-proof Class 1 Groups A, B, C, D (see Figure 4-1). The SensCast Monitor is designed to meet ISA 92.0.01 Part 1 for Toxic Monitors. The standard 10-0295 antenna fitting has an RP-TNC connector and is suitable for Division 2 classified areas. An optional explosion-proof dipole antenna is also available for Division 1 classified areas. Figure 4-2 shows both antenna styles.

4.2 SENSOR LOCATION

Factors such as air movement, gas density in relation to air, emission sources and environmental variables affect correct sensor location. Air movement by fans, prevailing winds and convection should be carefully evaluated to determine if a leak is more likely to raise gas levels in certain areas within the facility. Vapor density of a gas determines if it will rise or fall in air when there are no significant currents. Lighter than air gases should have the monitors mounted 12 – 18 inches (30 – 45 centimeters) above the potential gas leak and heavier than air gases should be this distance below. Even though the SENSCAST TRANSMITTER is designed for rugged service, sensors should be protected from environmental damage from water, snow, shock, vibration and dirt.

4.3 MOUNTING THE ENCLOSURE

The SENSCAST TRANSMITTER standard enclosures are the cast aluminum explosion-proof (NEMA 7) enclosure as shown in Figure 4-1 and the polycarbonate enclosure shown in Figure 4-2. Modular design simplifies the installation of the SENSCAST TRANSMITTER. The SENSCAST TRANSMITTER antenna should typically be mounted with line-of-site access to the SensCast Receiver's and/or SensCast Relayer's (SENSCAST RELAYER's) antenna. If a good line-of-site angle is not possible the SENSCAST TRANSMITTERs will usually still function properly at ranges up to 1500 feet. However, obstructions should still be kept to a minimum.

WARNING: Qualified personnel should perform the installation according to applicable electrical codes, regulations and safety standards. Ensure correct cabling and sealing fitting practices are implemented. Install the SENSCAST TRANSMITTER to a wall or bracket using the pre-drilled mounting flanges with I.D. 0.3 on 5.0 inch centers (Figure 4-1).

CAUTION: The sensor head (not shown in Figure 4-1) should never be installed pointing upwards.

4.3.1 SENSCAST TRANSMITTER 299-0072-01 MAGNETIC MOUNT OPTION

Sensidyne, LP offers a magnetic mounting option (299-0072-01) which includes two magnets affixed to the pre-drilled mounting holes securely attaching the assembly to a solid steel structure.

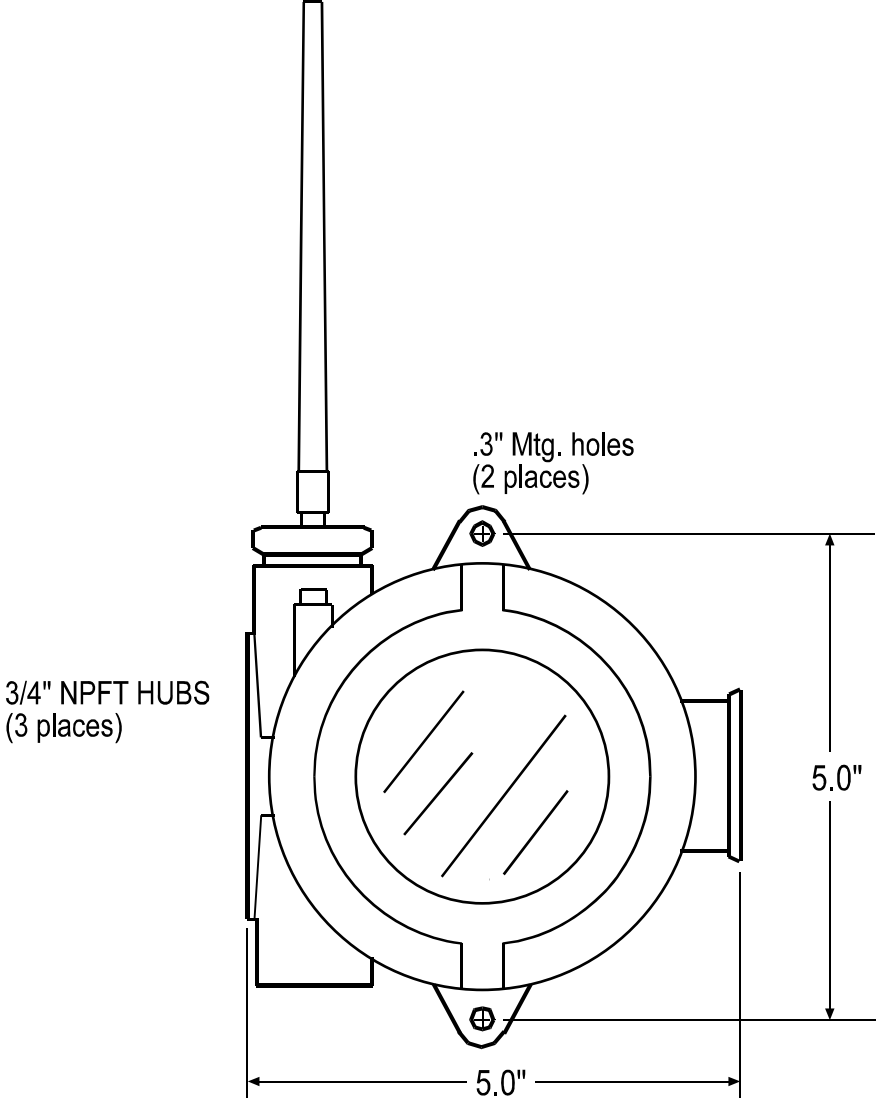

Figure 4-1 SENSICAST TRANSMITTER NEMA 7 Explosion-Proof Enclosure

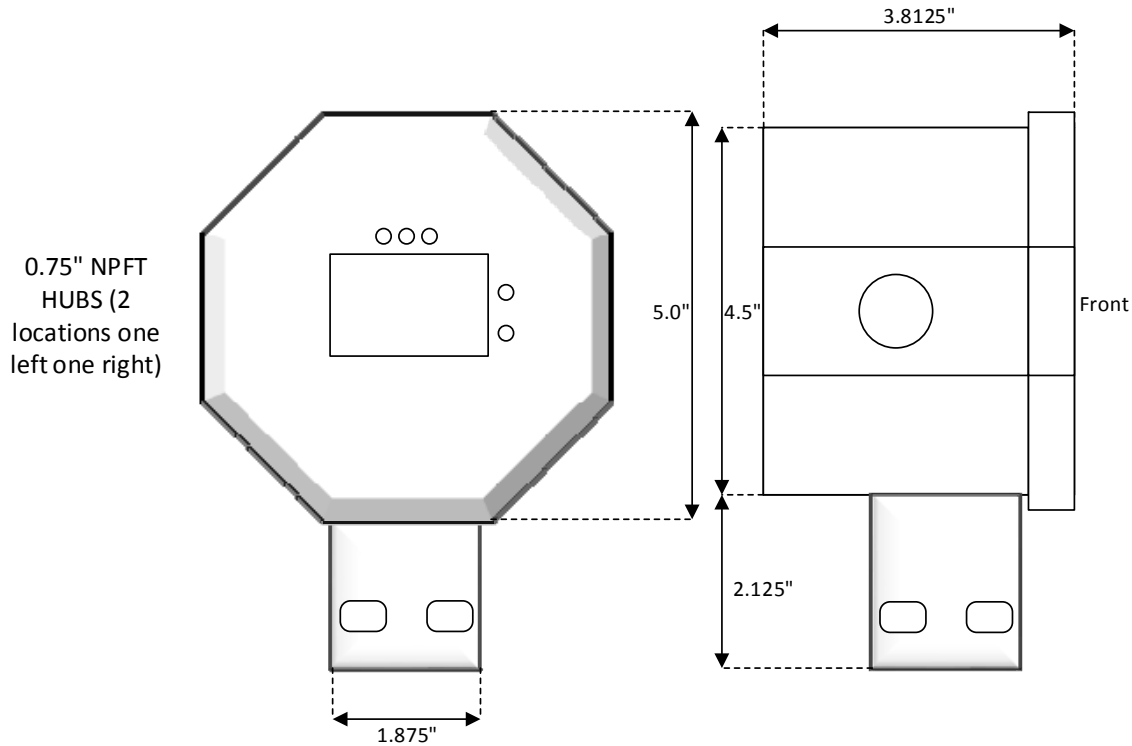

Figure 4-2 SENSICAST TRANSMITTER Polycarbonate Enclosure

4.4 SPECIFICATIONS

4.4.1 POWER SUPPLY

Integral non-rechargeable 3.6 volt 19AH Lithium D-cell battery. Replacement part # 10-2465.

4.4.2 POWER CONSUMPTION

900MHz Models:

2mA during "sleep" mode, 40mA while receiving beacon, up to 1 amp during 1 watt "transmit" mode. Transmit power may be set from 10mW to 1 watt (see [Section 8.1.9](#))

Note: 1 watt operation is not recommended or necessary for most applications as it can cause an unnecessary load on the battery thereby significantly reducing battery life.

2.4GHz Models:

2mA during "sleep" mode, 170mA during 125mW broadcasts.

4.4.3 MAXIMUM TRANSMIT (TX) POWER

900MHz Models (EIRP; 2dBi gain antenna):

30dBm at highest 1W power setting. Transmit power may be set from 10mW, 200mW, 400mW and 1 watt (see [Section 8.1.9](#))

Note: 1 watt operation is not recommended or necessary for most applications as it can cause an unnecessary load on the battery thereby significantly reducing battery life.

2.4GHz Models (Conducted; no antenna):

Transmit power is fixed at 125mW (21dBm)

4.4.4 RECEIVE (RX) SENSITIVITY

900MHz Models:

100 dBm

2.4GHz Models:

95 dBm

4.4.5 RADIO FREQUENCY

900MHz Models:

Hopping occurs between 902 – 928 MHz.

2.4GHz Models:

Hopping occurs between 2400 – 2483.5 MHz.

4.4.6 MEMORY:

Non-volatile E2 memory retains configuration values in the event of power outages.

4.5 ANTENNA TRANSMISSION RANGE

The distance radio signals can travel is dependent upon several factors including antenna design, transmitter power and free-space losses. In order for a wireless link to work, the available system operating margin (**TX power - RX Sensitivity + Antenna gains**) must exceed the free-space loss and all other losses in the system. For best RF line-of-site, the combined height of both antennas must exceed the Fresnel zone diameter.

<u>Dist. between ant's</u>	<u>Fresnel zone diameter</u>	<u>Freespace loss (dB)</u>
1000 ft (300 m)	16 ft (4.9 m)	81
1 Mile (1.6 km)	32 ft (9.7 m)	96
5 miles (8 km)	68 ft (20.7 m)	110

Example:

A 2.4GHz SensCast system has following parameters:

- RF TX power setting = 21 dBm (125 mW)
- RF RX sensitivity = -95 dBm (this is a constant)
- Antenna gain (standard equipped rubber collinear) = 7dBi x 2 = 14dBi

So the system operating margin is $21 - (-95) + 14 = 130$ dBm. This is enough to transmit 5 miles if free-space was the only loss in the system. For this to be the case, the antennas must be mounted with a combined height greater than 68ft above all obstructions (including the ground) to keep the Fresnel zone clear. In practice, however, there are many losses in the system besides just Free-space and it is recommended there be at least 20dB extra system operating margin.

RF “Rules of Thumb”:

- Doubling the range with good RF “Line of Sight” (LOS) requires an increase of 6 dB.

- Doubling the range without good RF LOS requires an increase of 12 dB.
- Doubling the power increases dBm by 3.

4.5.1 ANTENNA SELECTION & LOCATION

A site survey using test radios is highly recommended.

The location of the antenna is very important. Ensure the area surrounding the proposed location is clear of objects such as other antennas, trees or power lines which may affect the antenna's performance and efficiency. It is also vital that you ensure the support structure and mounting arrangement is adequate to support the antenna under all anticipated environmental conditions. The choice of appropriate mounting hardware is also important for both minimizing corrosion and maintaining site intermodulation performance.

Most installations with ranges under 1000 feet require only the standard equipped rubber antennas as shown in Figure 4-2. Distances up to 2 miles may be achieved by equipping the SENSICAST TRANSMITTERS with YAGI directional antennas aimed towards a mast mounted fiberglass omnidirectional antenna at the SENSICAST CONTROLLER/SENSICAST RELAYER base station. Always minimize obstructions between the SENSICAST TRANSMITTER and the SENSICAST CONTROLLER/SENSICAST RELAYER base station antenna.



Figure 4-3 Local Antennas

4.5.2 WATER PROOFING ANTENNA CONNECTIONS

Waterproof all outdoor coax connectors using a three layer sealing process of initial layer of adhesive PVC tape, followed by a second layer of self-vulcanizing weatherproofing tape such as 3M 23, with a final layer of adhesive PVC tape (see Figure 4-3).

1. Attach antenna to RP-SMA fitting



2. Wrap 20-24" strip PVC electrical tape onto hub, nut & base of antenna



3. Wrap 20-24" strip 3M 23 tape (order # 1000-2314) onto PVC tape



4. Wrap 24-28" strip PVC electrical tape over all



Figure 4-4 Water Proofing Antenna Connections

4.5.3 SYSTEM GROUNDING

Direct grounding of the SENSICAST TRANSMITTER enclosure via a good electrical connection to a well-designed grounding system is essential. This will protect your system, reduce the damage that can occur during lightning strikes and reduce noise.

Chapter 5 – SENSCAST MONITOR ROUTINE OPERATING INSTRUCTIONS

5.1 USING THE MAGNETIC KEYPAD

Each SensCast Monitor is supplied with a magnetic wand for operating the non-intrusive magnetic keypad. Keys are identified as UP, DOWN, NEXT and EDIT and function similar to touch keys except a “swiping” motion of the magnet is used instead of pressing a key. In this manual, a “swipe” means: hold the magnet directly over the key’s target, close to the enclosure’s glass cover, and in the same motion move the magnet away from the target. Each “swipe” equals one press of the key, and swipes may be done rapidly to move through fields with many options. It is ok to touch the glass with the magnet but be careful not to “swipe” too close to one of the other keys and activate it by mistake.

Modify a menu item by pointing to it, press the EDIT key to display the cursor, press UP / DOWN to change that character, press NEXT to move the cursor, then press EDIT again to load the new item and remove the cursor. Press NEXT to reverse out of the sub-menu.



Figure 5-1 1000-0078 Magnetic Wand

5.2 CYCLING SENSCAST TRANSMITTER POWER ON/OFF

It is not necessary to remove the instrument enclosure’s cover to cycle power ON or OFF. If the LCD readout is blank the SENSCAST TRANSMITTER is OFF. Apply power by holding the magnet over the UP key in the upper left front panel for a few seconds. When the LCD shows **Release Key**, pull the magnet away and power will remain ON. Turn the SENSCAST TRANSMITTER OFF by either using the Power Off menu (see [Section 8.5](#)) or by holding the magnet over the NEXT key in the upper right front panel. When the LCD shows **EDIT to Accept**, swipe the magnet over the EDIT key and power will turn off.

5.3 CAL MODE – ROUTINE CALIBRATIONS

Calibration is the most important function for ensuring correct gas readings at the SENSCAST TRANSMITTER. The CAL MODE (flow chart shown in Figure 5-3) is designed to make calibration quick, easy and error free. A successful ZERO and SPAN calibration requires only four keystrokes. CAL MODE is always followed by an adjustable CAL PURGE time period (see [Section 8.2.2](#)). CAL PURGE holds the output at a safe value to prevent alarms being tripped by the upscale span calibration gas.

Follow these SENSCAST TRANSMITTER calibration guidelines:

- Calibration accuracy is only as good as the calibration gas accuracy. Sensidyne, LP recommends calibration gases with NIST (National Institute of Standards and Technology) traceable accuracy to increase the validity of the calibration.
- Do not use a gas cylinder beyond its expiration date.
- Calibrate a new sensor before use.
- Allow the sensor to stabilize before starting calibration.

- Calibrate on a regular schedule. (Sensidyne, LP recommends once every 3 months, depending on use and sensor exposure to poisons and contaminants.)
- Calibrate only in a clean atmosphere, which is free of background gas.

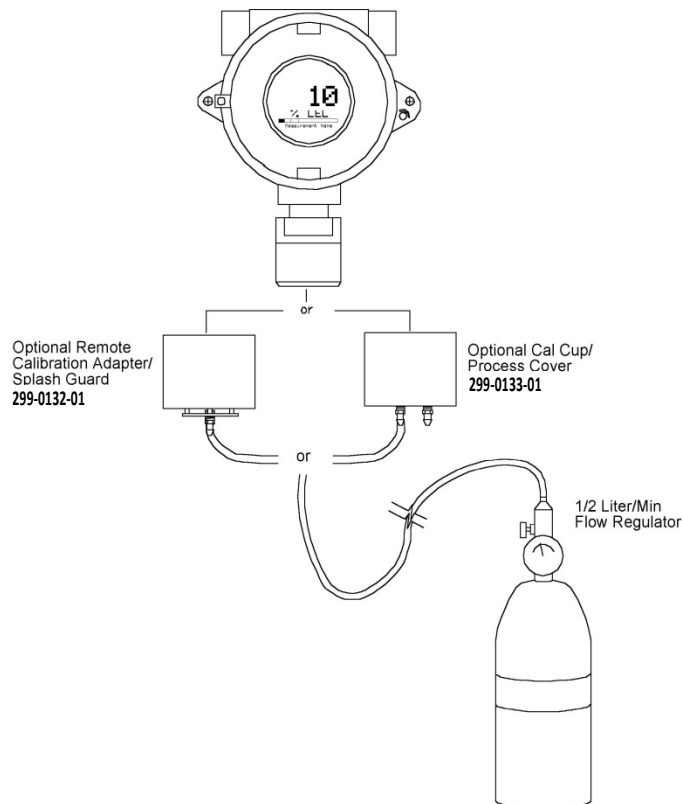

Figure 5-2 Calibration Gas Input

Use the following step-by-step procedure to perform ZERO and SPAN calibrations.

1. To enter the CAL MODE from the data displays, swipe the CAL / DOWN key and within 5 seconds swipe the EDIT key. **Note:** During SENSICAST TRANSMITTER calibrations, alarms are inhibited and "CAL MODE" is displayed on the SensCast Receiver.
2. Using the Cal-Cup (order # 299-0133-01) apply a clean ZERO gas or be sure there is no background target gas in the monitored area. After the reading is stable swipe the EDIT key to perform a ZERO calibration.
3. If the ZERO calibration is successful, swipe the NEXT key to proceed to the SPAN check.
4. Apply the **correct** SPAN gas at .5 liters/min. After the reading is stable swipe the EDIT key to perform a SPAN calibration.

WARNING: The SPAN gas used must match the value specified since this is what the SENSICAST TRANSMITTER will indicate after a successful SPAN calibration. The **Cal Span Value** may be edited if it becomes necessary to apply a different gas concentration (see [Section 7.2.6](#)).

5. If the SPAN calibration is successful, the display flashes "REMOVE CAL GAS" and starts the CAL PURGE delay (see [Section 8.2.2](#)). **Note:** During CAL PURGE, toxic monitors transmit 0% FS to the SENSICAST CONTROLLER to prevent alarms by residual upscale SPAN values. Oxygen monitors transmit a 20.9% oxygen reading during CAL PURGE to avoid tripping low oxygen alarms.
6. CAL MODE is complete after the end of the CAL PURGE delay.

The flow chart in Figure 5-3 illustrates the above procedure from left to right. UP, CAL, NEXT & EDIT labels indicate keystrokes using the magnetic wand. The CAL MODE information screen (top of the chart) is available for

advanced users to see Offset / Gain calibration constants and live analog to digital converter (A/D) counts. Span Gas calibration values may also be edited from this screen. Holding the UP key, for 5 seconds during CAL MODE, displays this screen.

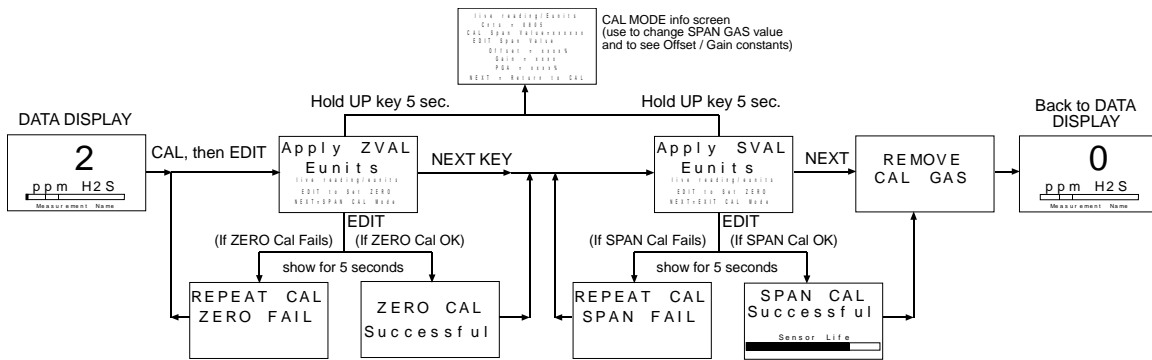

Figure 5-3 Cal-Mode Flow Chart and Menus

5.4 ALARM OPERATION

All alarm decision making is done by the SENSCAST TRANSMITTER with the results broadcast to the SENSCAST CONTROLLER/SENSCAST RELAYER. SENSCAST TRANSMITTERs have five front panel LEDs to indicate Alarm 1, Alarm 2 and Alarm 3, FAIL and COM (Broadcast). Alarm LEDs only flash during alarm events to conserve battery life. **Low Battery** is indicated by an icon on the LCD and by flashing the FAIL LED. **ONLY LEVEL ALARMS (A1, A2, A3) INCREASE WIRELESS BROADCASTS TO EVERY 6 SECONDS!** Alarms may be set to trip upon increasing and decreasing readings (see [Section 7.3.3](#)).

5.4.1 UNDERSTANDING FAIL ALARM OPERATION

The **FAIL** alarm indicates system related problems such as missing sensor, sensor failures, inability to synchronize to the Server and excessive negative readings. The Fault alarm menu described in [Section 7.3](#) allows setting how far below zero (negative) the reading may fall prior to tripping the FAIL alarm. The FAIL ALARM WILL ALSO TRIP WITH MISSING OR FAILED SENSORS REGARDLESS OF THE READING!

CAUTION: Missing or failed sensors always trip the FAIL alarm. FAIL alarm conditions DO NOT cause the radio broadcast rate to increase to 6 seconds.

5.4.2 LOW BATTERY CONDITION

The nominal battery voltage is 3.6 volts, and SENSCAST TRANSMITTERs trip their **Low Batt** alarm at < 3.3 volts. This causes the **Low Batt** icon to appear in the upper left hand corner of the display and the **Fail** LED to flash. At 3.2 volts the SENSCAST TRANSMITTER enters the replace battery mode. In this mode, there may be insufficient power to transmit a signal to the SENSCAST CONTROLLER/SENSCAST RELAYER it is connected to which will most likely result in a Comm Error ([Section 3.2](#)). In this mode, the SENSCAST TRANSMITTER will alternate, every six seconds, between the Replace Battery Screen (Figure 5-4) and the screen which was previously being monitored. It will continue in this manner until the battery is replaced ([Section 3.3](#)) or the battery no longer carries a sufficient voltage to power the unit.

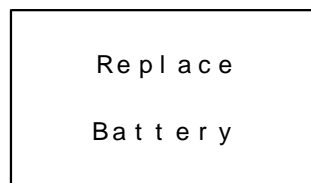

Figure 5-4 Replace Battery Screen

5.5 SMART SENSOR MODULES

Each SENSCAST TRANSMITTER may be supplied with either one, or two, “Smart Sensor” gas sensor modules mounted locally to the SENSCAST TRANSMITTER enclosure, or up to 15 feet away with the 299-0091-01 “Sensor Separation Kit”. “Smart Sensors” utilize a unique **Smart Sensor Interface** to transfer necessary configuration parameters from the Smart Sensor’s memory to the SENSCAST TRANSMITTER whenever a new sensor is installed. The “Smart Sensor Info” screen appears at power up and anytime a sensor module is removed and installed again. If a sensor is installed that does not match gas type of the previous sensor, the operator must manually approve the new sensor in order for the SENSCAST TRANSMITTER to accept the new gas type (Figure 5-4).

Local sensor heads have a *Smart Sensor* cable connected to S1 (Channel 1) and/or S2 (Channel 2) of the 299-0084-01 Battery / I/O PCB (see Figure 3-2).

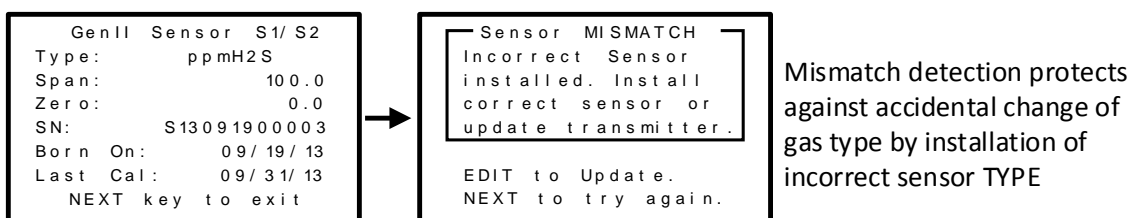

Figure 5-5 Smart Sensor Info / ERROR Screens

5.5.1 SENSCAST TRANSMITTER 299-0091-01 SENSOR SEPARATION KIT

Smart Sensor heads may be remote mounted up to 15 feet using the 299-0091-01 sensor separation kit connected to TB1 or TB2 of the 299-0084-01 Battery / I/O PCB (see Figure 3-2). The 299-0091-01 Sensor Separation Kit comes with 15 feet of data cable (1000-2730) and assures proper communication over the **Smart Sensor Interface**. Alternate cable types and longer distances are not approved and may result in poor performance.



Figure 5-6 Sensor Separation Kit 299-0091-01

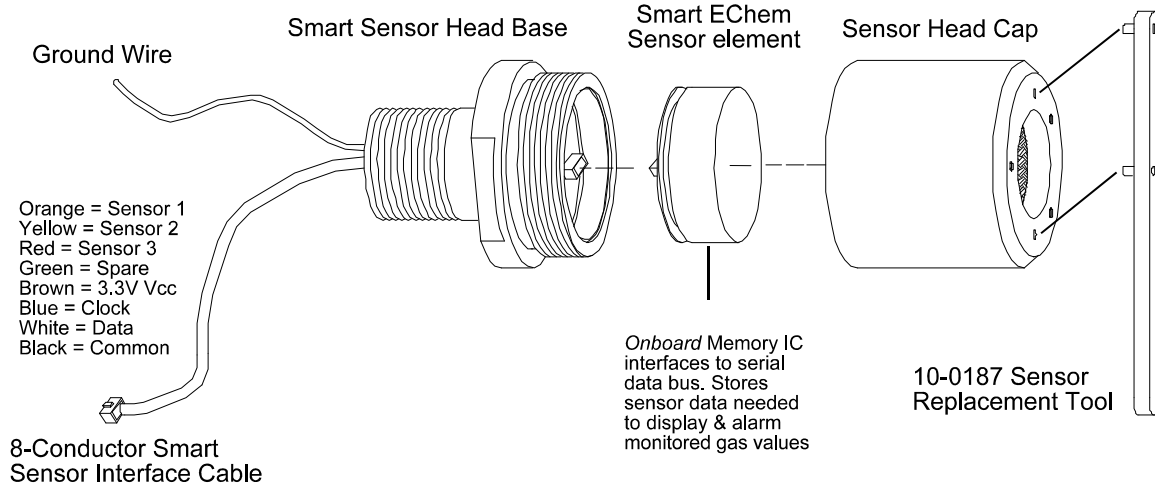

Figure 5-7 299-0069-01 Smart Sensor Head Assembly

Chapter 6 – SENSCAST MONITOR SETUP MENUS

6.1 MENU STRUCTURES

SensCast Monitor configuration parameters are stored in its non-volatile menu database. Menus are accessed by swiping the EDIT key from any data display. This displays the **MAIN MENU** with a path to **Channel 1**, **Channel 2**, **Device Setup** and **Help** menus. **Channel 1** and **Channel 2** have two separate but identical menu structures which determine how readings and alarms function for each channel. Menus contain nominal default values from the factory which may be edited by the operator to better match the particular application. [Section 7](#) is dedicated to describing **Channel** menus.

Device Setup contains menus not pertaining to either channel but to the unit as a whole. These include Security, Clock/Calendar, Delays, and how the SENSCAST TRANSMITTER communicates to the wireless network. [Section 8](#) is dedicated to describing **Device Setup** menus.

6.2 MAIN MENU

The **MAIN MENU** setup screen is shown in Figure 6-1. The UP / DOWN keys maneuver the pointer while EDIT enters sub-levels of menu items. All **MAIN MENU** items have at least one page of sub-menus indicated by the > symbol (right hand pointing arrow) at the end of each line. Change a menu item by:

1. Select UP/DOWN key so that the arrow on the left is pointing to the desired menu item.
2. Select the EDIT key to display the cursor.
3. Select UP / DOWN to change that character.
4. Select NEXT to advance the cursor.
5. Select EDIT again to load the new item, and remove the cursor.
6. Select NEXT to reverse out of the sub-menu.

The MAIN MENU is the pathway to **CHANNEL 1 / 2** menus, **Device Setup** menus and the **Help** pages. A channel should only be activated if it has a sensor connected to the 299-0084-01 Battery / I/O board. The **Device Setup** group (see [Section 8](#)) contains parameters affecting the entire SENSCAST TRANSMITTER regardless of channel.

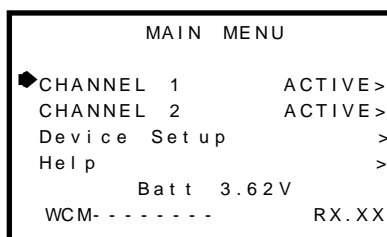

Figure 6-1 Main Menu Entry

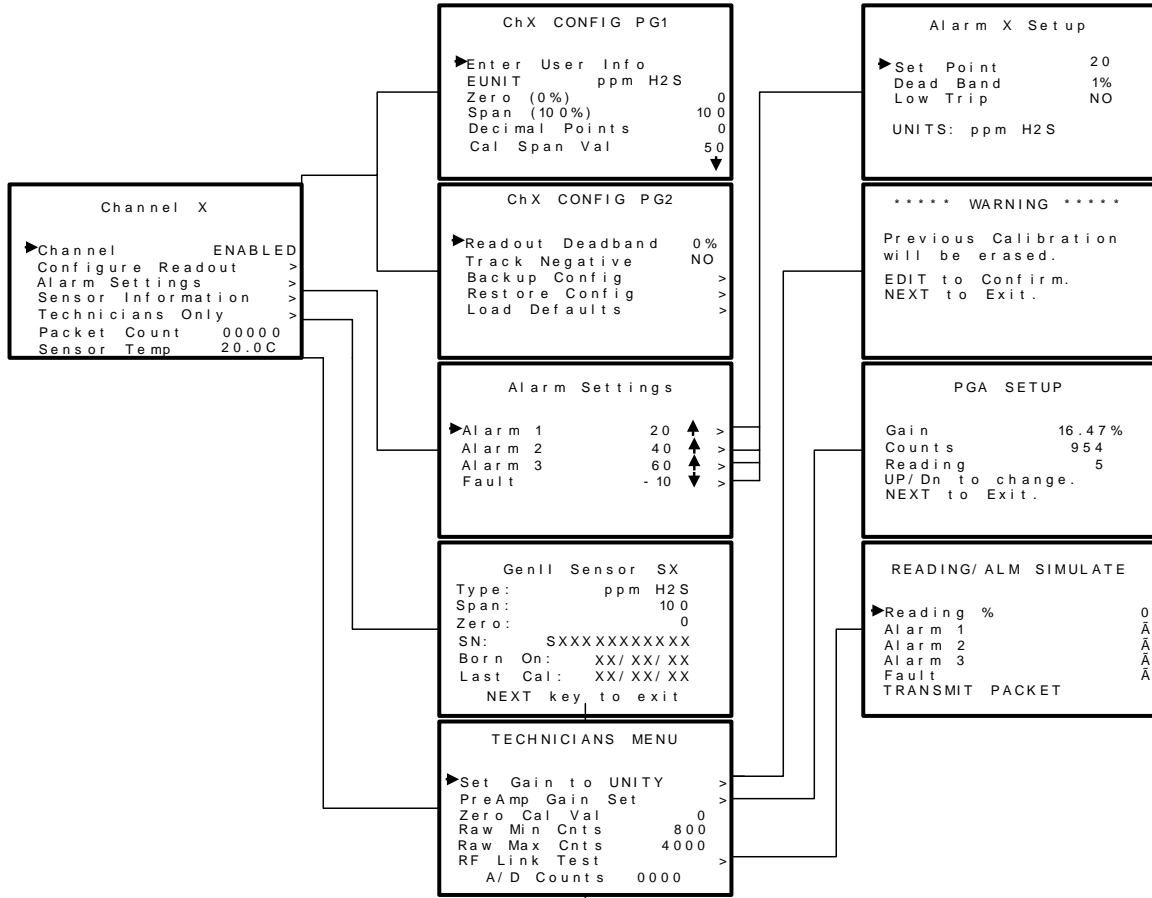

Figure 6-2 SensCast Monitor Channel Configuration Menu Tree

Chapter 7 – SENSCAST MONITOR CHANNEL SETUP MENUS

The CHANNEL 1 / CHANNEL 2 menus accessed from the MAIN MENU are shown in Figure 7-1.

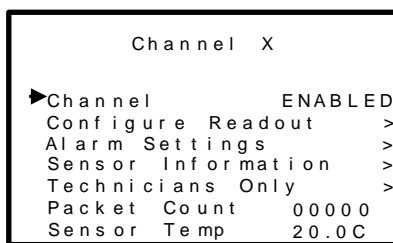

Figure 7-1 Channel Setup Menus

7.1 CHANNEL ENABLE / INACTIVE

Use the top menu in the group to make this channel either “ENABLED” or “INACTIVE”. Channels should only be activated if a sensor is connected (see [Section 5.5](#)).

7.2 CONFIGURE READOUT

The Configure Readout group shown in Figure 7-2 has 2 pages of menus for controlling how sensor signals are displayed and alarms are activated for this channel.

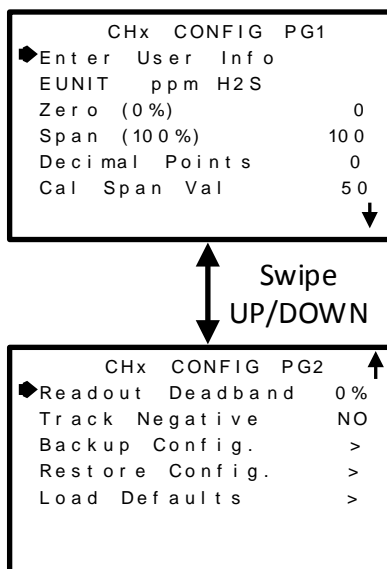

Figure 7-2 Configure Readout Setup Menus

7.2.1 MEASUREMENT NAME

The **Measurement Name** field may be edited to contain virtually any 16-character ASCII string. It is typically used to describe the monitored point by user tag # or other familiar terminology.

7.2.2 EUNIT

Eunit (engineering unit) may have up to a 10 character ASCII field and is used to clearly identify the target gas and units of measure such as %, ppm or ppb.

7.2.3 ZERO (0%)

Zero (0%) defines the reading to be displayed when the monitored value = 0% of full scale.

7.2.4 SPAN (100%)

Span (100%) defines the reading to be displayed when the signal = 100% of full scale. The highest numeric reading allowed is 9999 including negative polarity sign and one decimal point. Polarity is only indicated for negative readings.

7.2.5 DECIMAL POINTS

Decimal Points determine the resolution of the LCD readings, and may be set to 0, 1 or 2 decimal points. Example: ZERO readings for 0, 1 & 2 DPs respectively are 0, 0.0 and 0.00.

7.2.6 CAL SPAN VAL

Cal Span Val sets the upscale gas value that must be applied when performing Span calibrations. This is typically at least 50% of the full scale range. Calibration accuracy is dependent on this setting matching the value of target gas in the span gas cylinder used during routine Span calibrations (see [Section 5.3](#)).

7.2.7 READOUT DEAD BAND

Readout Dead band allows forcing low readings to continue to read zero. This is useful when there are very small, safe, levels of background target gas that cause fluctuating readouts above zero. The highest amount of dead band allowed is 5% of the full scale range. Example: If the range is 0 – 10.0 ppm, setting **Dead band** to 3% would mean the readout continues to display 0.0 until the value exceeds .3 ppm.

7.2.8 TRACK NEGATIVE

Track Negative, set to NO, causes negative values to read the **Zero (0%)** value in data displays. The CAL MODE readout will display negative values regardless of this setting. Negative values below the Fault set point will still cause the Fault alarm to trip (see [Section 5.4.1](#)).

7.2.9 BACKUP CONFIG

Backup Config allows users to store the **CHANNEL** menu parameters into non-volatile memory for restoration later, if incorrect values are accidentally entered or uploaded.

7.2.10 RESTORE CONFIG

Restore Config restores the **CHANNEL** menu database to the values from the most recent **Backup Config** the special keystroke sequence of 4 consecutive UP keys is required to perform the **Restore** operations.

7.2.11 LOAD DEFAULTS

Users are encouraged to modify the **Channel** parameters described in this section when it helps tailor the SENSCAST TRANSMITTER to their project. However, at some point it may be desirable to return all of these settings to their original factory defaults values. Each smart sensor has a protected database containing a copy of the original factory default values which the SENSCAST TRANSMITTER user cannot modify. The **Load Defaults**

menu retrieves these original factory default values from the smart sensor and repopulates all **Channel** menus to match.

7.3 ALARM SETTINGS

The **Alarm Settings** page includes the **Alarm 1, 2, 3** and **Fault** menus shown in Figure 7-3. Alarm conditions are indicated by “A1”, “A2”, “A3” and “FAULT” LCD icons on data displays and by flashing the A1, A2, A3 and FAIL LED’s. The FAIL LED also flashes if the SENSICAST TRANSMITTER detects a missing or defective sensor. Up or Down pointing arrows indicate if the alarm is set for a high or low trip respectively.

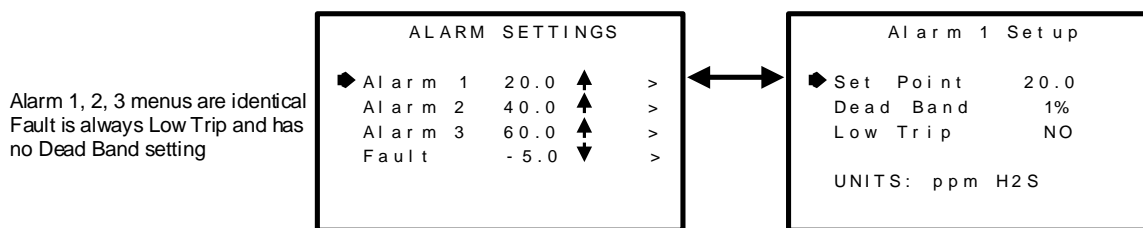

Figure 7-3 Alarm Settings Menus

7.3.1 SET POINT

Set Point enters the **Eunit** value where the alarm trips. The Fault Set Point may only be set for negative values between 0% and -10% of range and is always Low Trip. This makes it function as a FAULT alarm and trip when the monitored value is out-of-range negative.

7.3.2 DEAD BAND

Dead Band for A1, A2 and A3 have a minimum value of 1% and a maximum value of 10%. **Dead Band** is useful for preventing alarm cycling when the monitored value is hovering around the set point. EXAMPLE: With a range of 0-100 ppm, if Dead-Band equals 5% and the set point is 20 ppm, after tripping at 20 ppm the value must drop below 15 ppm to reset. **Dead Band** for the Fault alarm is fixed at 1%.

7.3.3 LOW TRIP

Low Trip for A1, A2 and A3 set to YES causes the alarm to trip as the value falls below the set point. The Fault alarm is always a **Low Trip**.

7.4 SENSOR INFORMATION

The **Sensor Information** page shown in Figure 7-4 displays important values for the Smart Sensor installed. The SENSICAST TRANSMITTER Smart Sensor interface automatically detects new Smart Sensors and updates this page any time a new sensor is installed.

```
GenII Sensor S1/ S2
Type:      ppmH2S
Span:      100.0
Zero:      0.0
SN:        S13091900003
Born On:   09/ 19/ 13
Last Cal:  09/ 31/ 13
NEXT key to exit
```

Figure 7-4 Smart Sensor Information Screen

Type, Span, Zero, SN (Serial Number) and **Born On Date** are set at the factory and may not be modified. **Last Cal** date updates each time the CAL MODE is performed (see [Section 5.3](#)). **Type** indicates what kind of sensor is plugged into this SENSICAST TRANSMITTER channel. **Span / Zero** indicate the nominal gas range for this sensor but not necessarily what the user's range must be. For example, the nominal Span of an H2S sensor might be 100 ppm but the user may decide to set his SENSICAST TRANSMITTER Span for only 50 ppm. See **Preamp Gain** [Section 7.5.2](#) to learn how to set the SENSICAST TRANSMITTER span for a different range than the Smart Sensor's nominal Span. **Born On Date** shows when the sensor was originally configured at the factory.

7.5 TECHNICIANS ONLY

WARNING! Users of these menus must have a detailed understanding of their functions. Monitoring of target gases, processing of alarms and wireless communications should not be relied upon while editing these menus! **Back-up the current configuration prior to altering any Technician menus in case Restore is required later (see [Section 7.2.10](#)).**

The **TECHNICIAN ONLY** menu group in Figure 7-5 contains items that are **factory configured** depending upon the type of sensor input connected to the SENSICAST TRANSMITTER. They should not be tampered with after installation. If configured incorrectly, some items will prevent accurate monitoring of target gases. **Access requires a special key sequence of four consecutive UP keystrokes** to prevent accidental modification of critical items.

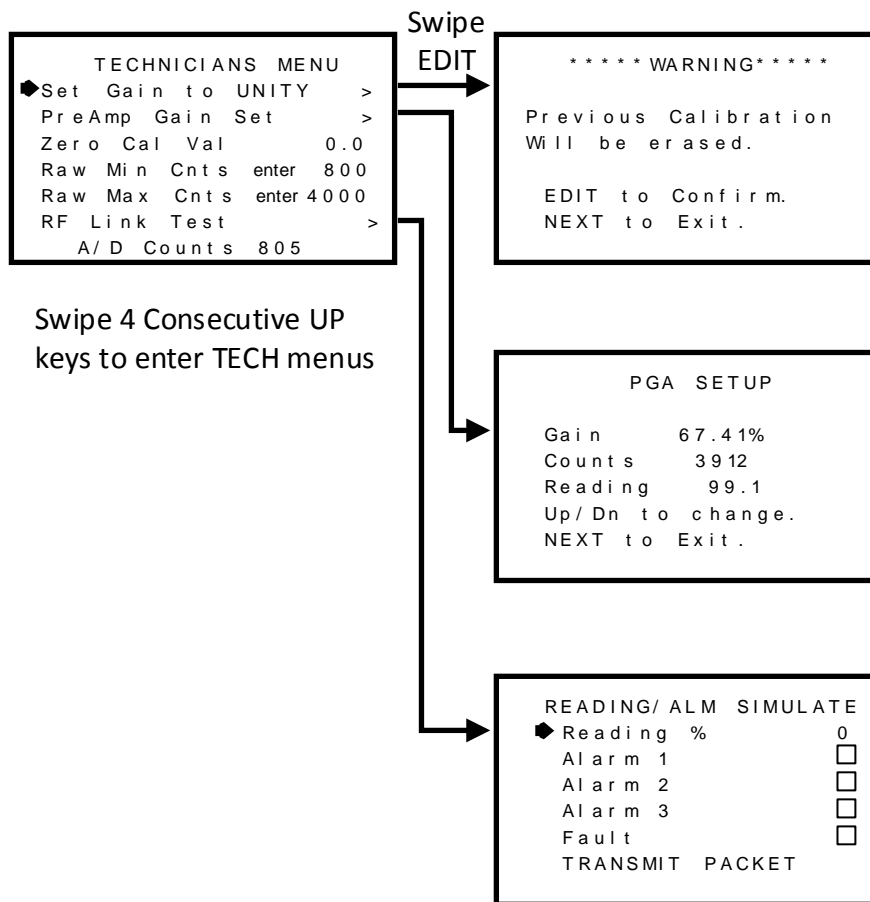

Figure 7-5 Technicians Menu Tree

7.5.1 SET GAIN TO UNITY (TECHNICIANS ONLY!)

Set Gain to UNITY allows resetting previous calibration OFFSET to zero and GAIN to one. This is the definition of UNITY. A calibration should be performed after setting UNITY (see Cal Mode [Section 5.3](#)).

7.5.2 PREAMP GAIN ADJUST (PGA) (TECHNICIANS ONLY!)

Gas sensors have a very wide output signal range, across the many gas types, and there are several full scale ranges for each type. **Preamp Gain** is the adjustment that matches the sensor element's signal range to the Smart Sensor's input signal conditioning circuits. The **Preamp Gain** value is saved into non-volatile memory on the Smart Sensor module. Altering the Preamp Gain automatically resets previous calibration OFFSET and GAIN values to UNITY as described in [Section 7.5.1](#).

If it is determined the **Preamp Gain** value is incorrect, apply the desired up-scale target gas value to the sensor and use the UP / DOWN keys to obtain the correct **Reading** value. **Counts** are the 12-bit binary A/D value with an active range value of 800 – 4000 for 0-100% of full scale.

CAUTION: For standard installations this is a factory adjustment. Do not use the **Preamp Gain** menu for calibrating sensors. It should only be adjusted if a new measurement gas or input range is required.

7.5.3 ZERO CAL VALUE (TECHNICIANS ONLY!)

The **Zero Cal Value** menu entry allows the zero calibration value to be set for something other than a zero reading. In rare cases it may be necessary to perform Zero calibrations at some other engineering unit reading than zero. Do not exceed 25% of full scale.

7.5.4 RAW MIN / MAX COUNTS (TECHNICIANS ONLY!)

The **Raw Min / Max Counts** menus determine the range of 12-bit analog to digital (A/D) converter counts that define 0 and 100% of full scale. The default range is 800 – 4000 counts. **Raw Min A/D** counts create 0% readings, and **Raw Max A/D** counts create 100% readings. The corresponding **Zero 0%** and **Span 100%** readouts that appear on data displays are entered in the CHANNEL Configuration Menu describe in [Sections 7.2.3](#) and [7.2.4](#). Live A/D count input values may be viewed on the **Preamp Gain** screen and the **CAL MODE** Information screens described [Sections 7.5.2](#) and [5.3](#).

7.5.5 RF LINK TEST (TECHNICIANS ONLY!)

The **RF LINK TEST** shown in Figure 7-6 is a diagnostics tool which allows readings of 0%, 25%, 50%, 75% or 100% of the full scale range to be broadcast to any SensCast Receiver and/or SensCast Relay on the same network. Alarms may also be sent by filling the check box. After the menu is ready, simply point to TRANSMIT PACKET menu and swipe the EDIT key. The broadcast is made every time the EDIT key is swiped. **RF LINK TEST** is very useful for troubleshooting and testing a new installation.

IMPORTANT! SENSICAST CONTROLLER/SENSICAST RELAYER relays do activate if alarms boxes are checked!

READING/ ALM	SIMULATE
◆ Reading %	0
Alarm 1	<input type="checkbox"/>
Alarm 2	<input type="checkbox"/>
Alarm 3	<input type="checkbox"/>
Fault	<input type="checkbox"/>
TRANSMIT PACKET	

Figure 7-6 RF Link Test

7.5.6 SENSOR TEMP COMP TABLE (TECHNICIANS ONLY!)

Signals from electrochemical sensor elements used in SENSICAST TRANSMITTER Smart Sensor modules may be affected by temperature extremes. SENSICAST TRANSMITTER Smart Sensors are equipped with an on board temperature sensor which monitors temperature of the sensor element. Sensor types have a matching Temperature Compensation profile which is stored with each Smart sensor in the table shown in Figure 7-7. This TEMP COMP TABLE is a hidden menu but may be accessed from the TECHNICIANS MENU by holding the DOWN key until it appears.

S1 TEMP COMP TABLE	
◆ Data Point	20.0C
Gain	1.000
% Offset	0.000
<hr/>	
Comp ed	0.0
UnComp ed	0.0
Sensor Temp	23.5C

Figure 7-7 Temperature Compensation Table

The temperature **Data Points** scroll by in 10 degree C increments from -40C to + 60C with each swipe of the EDIT key. Each Data Point has an associated **Gain** and **Offset** value. Electrochemical sensors may be less sensitive to the target gas at lower temperatures than at higher temperatures and therefore require higher gain when cold and less gain when hot. To accomplish this, **Temp Comp Table Gain** is typically 1.000 at 20C and increases gradually at the colder Data Points and decreases at warmer. Some sensors may also have a shift in zero output at extreme temperatures. The **Offset** values add or subtract in % of full scale using the following formula: **Gain (Uncomp ed – Offset) = Comp ed**. Note that Offset values entered with a negative number actually add to the reading. **Sensor Temp** is a live readout from the current temperature of the sensor element.

7.6 PACKET COUNT

Packet Count appears at the bottom of Channel Setup menu, and is a 5 digit decimal number indicating the number of transmissions the SENSICAST TRANSMITTER has transmitted since the last reset; up to 65,535 transmissions. This is a useful diagnostic tool for comparing how many times the SENSICAST TRANSMITTER transmits to the number of transmissions received by receivers over a period of time

When the SENSICAST TRANSMITTER is in dual channel mode each channel will display the number of transmissions for that channel independently, on its respective Channel Setup Menu (Figure 7-1).

The TX Counter is reset by moving the cursor to the Packet Count line and selecting EDIT, or by cycling power to the SENSICAST TRANSMITTER.

7.7 SENSOR TEMP READING

The last item on the CHANNEL menu page is a live reading of the Smart Sensor's temperature. This reading is used if the sensor element requires temperature compensation (see [Section 7.5.6](#)).

Chapter 8 – SENSCAST MONITOR DEVICE SETUP MENUS

The **Device Setup** group shown in Figure 8-1 contains parameters affecting the entire SensCast Monitor regardless of channel. These include Security, Clock/Calendar, Delays, and how the SENSCAST TRANSMITTER communicates to the wireless network.

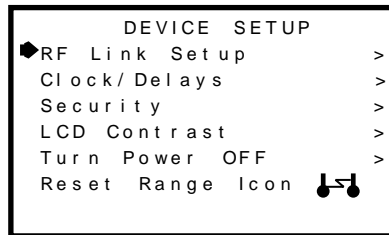

The “Reset Range Icon” menu only appears if the WCS was out of range of the Server during a previous broadcast attempt. To reset the Range Icon select the Reset Range Icon option.

Figure 8-1 Device Setup Menus

8.1 RF LINK SETUP

RF LINK SETUP provides access to a group of menus for configuring how the SENSCAST TRANSMITTER broadcasts its data to the SensCast wireless network. Items tagged with an asterisk affect power consumption and battery life.

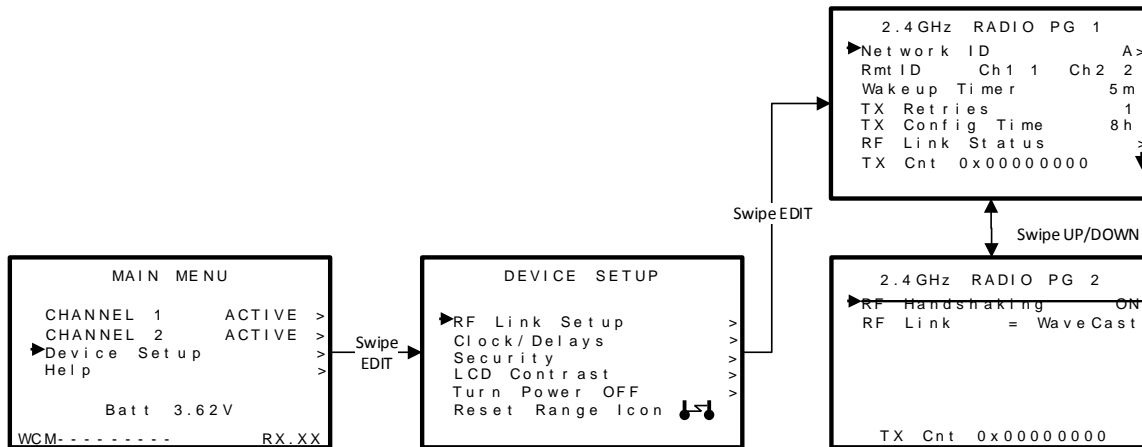

Figure 8-2 RF Link Setup Menu

8.1.1 NETWORK ID

SensCast devices utilize the **Network ID** setting to assign up to 26 unique hopping patterns. To simplify system setup, **Network ID** is entered using letter designators “A” through “Z” where A = [Hop Channel 1, System ID 1] and Z = [Hop Channel 26, System ID 26]. A SENSCAST TRANSMITTER will not indicate Server In-Range status or communicate with any SensCast Receiver and/or SensCast Relayer operating on a different **Network ID**. This feature allows multiple SensCast wireless systems to be located within range of each other without interference.

Networks M through Z are encrypted networks. When one of these networks is selected the data will be encrypted via proprietary methods to ensure that only devices on that network, which hold the encryption key, will be able to decipher the data being transmitted.

IMPORTANT! Explore what frequencies are appropriate for the final location of any wireless system.

8.1.2 RMTID

SensCast systems allow up to 32 SENSCAST TRANSMITTER **RTU #s** per network. **IMPORTANT!** Dual sensor SENSCAST TRANSMITTERs have two **RTU #s** and they are always consecutive. For example, setting the **RTU #** of Sensor 1 to 5 automatically sets this SENSCAST TRANSMITTER's Sensor 2 **RTU #** to 6. The SENSCAST TRANSMITTER **RTU #** is used by the SENSCAST CONTROLLER/SENSCAST RELAYER to control which channels the sensor readings are displayed on, and how its relays are tripped. It is not necessary for SENSCAST TRANSMITTER **RTU #s** AND SENSCAST CONTROLLER/SENSCAST RELAYER CHANNEL NUMBERS TO MATCH. A separate SENSCAST CONTROLLER/SENSCAST RELAYER menu allows random matching of SENSCAST CONTROLLER/SENSCAST RELAYER Channel numbers to SENSCAST TRANSMITTER **RTU #s**. This is useful for creating "zones" where monitors with the same gas type may be displayed on consecutive SENSCAST CONTROLLER/SENSCAST RELAYER channels.

8.1.3 *WAKEUP TIMER

The **Wakeup Timer** menu determines how often the SENSCAST TRANSMITTER broadcasts its data when there is no A1, A2 or A3 LEVEL ALARM. Active A1, A2, A3 alarms override the **Wakeup Timer** and schedule broadcasts 6-seconds after each previous broadcast. The **Wakeup Timer** range is 1 minute – 5 minutes with 5 minutes being the default value.

Note: Broadcast intervals will actually be a few seconds longer than the value entered since the SENSCAST TRANSMITTER radio module must be powered up and achieve Server In-Range status prior to broadcasting.

IMPORTANT: More frequent RF broadcasts deplete the battery faster!

8.1.4 *TX RETRIES

The **TX Retries** menu allows EVERY broadcast to be repeated up to 5 times with a 200mS delay between each repeated broadcast. Each repeated broadcast will appear as a separate blink of the SENSCAST TRANSMITTER's TX LED and the SENSCAST CONTROLLER/SENSCAST RELAYERS RX LED.

The default setting of 1 should only be increased if there is no other way to improve communications success. Increasing **TX Retries** may be a viable way to improve communications if there are other high power RF radiators near SensCast antennas, and it is not possible to relocate the antennas. Power consumption increases with radio broadcasts, and battery life will be affected by raising the **TX Retries** setting.

Transmissions will perform as follows for the TX Retries settings:

1. **TX Retries** set to **1, 2 or 3**: the SENSCAST TRANSMITTER automatically transmits one, two and three times respectively.
2. **TX Retries** set to **4**: the SENSCAST TRANSMITTER transmits until an acknowledgement is received from the server or four times, whichever comes first.
3. **TX Retries** set to **5**: the SENSCAST TRANSMITTER transmits until an acknowledgement is received from the server or five times, whichever comes first.

8.1.5 *TX CONFIG TIME

TX CONFIG TIME may be set from 0 to 18 hours and determines how often the SENSCAST TRANSMITTER broadcasts all of the CHANNEL CONFIG parameters to the SENSCAST CONTROLLER/SENSCAST RELAYER. Broadcasts normally include only monitored gas values and alarm status, but at least hourly, all configuration is sent to the SENSCAST CONTROLLERS to assure identical readings at all locations. The configuration data is also broadcast

whenever any menu containing these parameters is edited or manually by holding the UP key for 5 seconds. This longer broadcast takes approximately 1 second to complete.

Setting TX Config Time to 0 means that the SENSICAST TRANSMITTER will not send all of the Channel Config parameters to the SENSICAST CONTROLLER/SENSICAST RELAYER automatically, and these parameters must be sent by holding the UP key for 5 seconds.

8.1.6 RF LINK STATUS

RF Link Status opens another screen that shows if the SENSICAST TRANSMITTER is In-Range of the Server and what the battery voltage is currently. The radio remains active during this screen so the range status is displayed in real time. Battery voltage is also displayed on the MAIN MENU.

* **TX Multiples(900MHz and 2.4GHz)**, **RF Handshaking(900MHz)** and **TX Power(900MHz)** menu settings are available to improve communications reliability by increasing the quantity and power of wireless broadcasts.

IMPORTANT! Ensure proper selection and location of antennas before increasing **TX Multiples** and **TX Power** settings. Battery life will be reduced by increasing these settings. Proper selection and location of antennas is more important to successful communications and will not sacrifice battery life.

8.1.7 *RF HANDSHAKING (900MHZ MODELS ONLY)

RF Handshaking must be OFF if there is more than one SENSICAST CONTROLLER/SENSICAST RELAYER receiving SENSICAST TRANSMITTER broadcasts. The default OFF setting causes every SENSICAST TRANSMITTER broadcast to repeat 3 times in rapid succession (these appear as a single blink of the TX LED and are unrelated to **TX Multiples**). The ON setting requests an Acknowledge, or, "Handshake" from the Server. With **RF Handshaking = ON**, the SENSICAST TRANSMITTER broadcasts only once if the Acknowledge is received, and up to 3 times if an Acknowledge is not received.

IMPORTANT! The ON setting allows more efficient communications but must only be utilized when broadcasting to a single SENSICAST CONTROLLER/SENSICAST RELAYER configured as Server. Multiple SENSICAST CONTROLLERS/SENSICAST RELAYERS, listening on the same **NETWORK ID**, will have acknowledge data collisions if the SENSICAST TRANSMITTER **RF Handshaking = ON**.

RF HANDSHAKING = OFF may be used for any application, but is required when broadcasting to a SENSICAST CONTROLLER/SENSICAST RELAYER Server and other SENSICAST CONTROLLER/SENSICAST RELAYER Clients.

8.1.8 *RF LINK

RF Link will change the mode in which the SENSICAST TRANSMITTER will communicate. The default setting is the SensCast mode which is discussed in detail in [Section 8](#). By selecting **RF Link** the mode may be changed to Legacy Mode, which is discussed in [Chapter 17](#).

8.1.9 *TX POWER (900MHZ MODELS ONLY)

TX Power (900MHz models only) may be set for 10mW, 200mW and 400mW (EIRP based upon a 2 dBi antenna). Since SENSICAST TRANSMITTERs are battery powered the **TX Power** setting should be as low as possible to sustain reliable communication. The maximum **TX Power** setting is 30db (1 watt) and each time TX power is reduced by half, antenna transmit power is reduced by 3dB.

Note: 1 watt operation is not recommended or necessary for most applications as it can cause an unnecessary load on the battery thereby significantly reducing battery life.

Under normal operations the SENSCAST TRANSMITTER cannot be set to 1 watt. In order to set the SENSCAST TRANSMITTER to 1 watt hold the up key for 5 seconds while at the bottom of the radio menu. A1 and A3 LEDs will flash to indicate the change, and now 1 watt is an available option under TX Power.

2.4GHZ variation: The TX Power menu is not available in 2.4GHZ models and is fixed at 125mW conducted.

8.1.10 TX CNT (TRANSMIT COUNTER)

TX Cnt. (Transmit Counter) appears at the bottom of the RF LINK page and is an 8 digit hexadecimal counter that appears as 0x00000000. The highest count would be 0xFFFFFFFF, or 4,294,967,295 decimal. It is useful as a diagnostic tool for counting how many times the SENSCAST TRANSMITTER broadcasts over any given period of time. To reset the TX Cnt hold the CAL/DOWN key when on the RF Link Setup menu.

When in dual channel mode this number combines the transmissions from each channel.

8.2 CLOCK, WARM-UP and CAL PURGE DELAYS

The SENSCAST TRANSMITTER is equipped with a Real Time Clock and Calendar so **Time** and **Date** must be set to correctly match its location. They are set at the factory in a 24 hour format but may require adjustment to match the location's time and date after shipment. **Warm Up** and **Cal Purge** time delays are also available to prevent unwanted alarm trips. Figure 8-3 shows the menu for these items.

8.2.1 WARM UP TIMER

The **WARM UP** timer is has a default setting of 60 seconds but may be between 0 – 254 seconds. The primary purpose of the warm up timer is to allow sensor stabilization after power up.

8.2.2 CAL PURGE TIMER

The **CAL PURGE** timer has a default setting of 60 seconds, but may be set between 0 – 254 seconds. The primary purpose is to allow sensor stabilization after a Span calibration (see [Section 5.3](#)). A purge interval is needed after the span calibration, because up-scale readings will linger until the span gas exits the sensor head. Alarms are inhibited during the **CAL PURGE** interval.

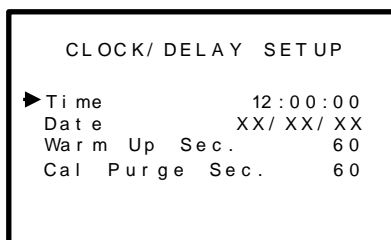

Figure 8-3 Clock & Calendar / Delay Timer Menu

8.3 SYSTEM SECURITY

The **SYSTEM SECURITY** menu in Figure 8-4 offers two levels of protection. A **LOW** level allows CAL MODE sensor calibrations, but requires the 4-digit **Pass Code** prior to altering menus. **HIGH** level locks the entire menu

database, plus CAL Mode, until the correct **Pass Code** is entered. **LOW** and **HIGH** security levels always allow viewing of configuration menus but they may not be modified. **Contact Name** is a 12 character ASCII field available for displaying a phone #, or name, of personnel who manage the **Pass Code**.

Lost **Pass Codes** may be recovered by entering the locked security menu and holding the UP key for 5 seconds. The 4-digit code appears near the bottom of the screen.

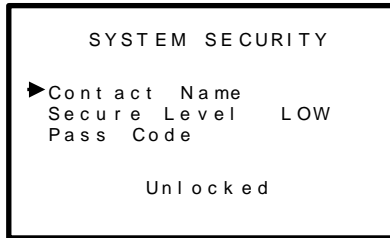

Figure 8-4 System Security Menu

8.4 LCD CONTRAST ADJUST

LCD Contrast Adj. may be set for optimum viewing using the menu shown in Figure 8-5. To adjust swipe the UP/DOWN keys, and swipe next to save and exit.

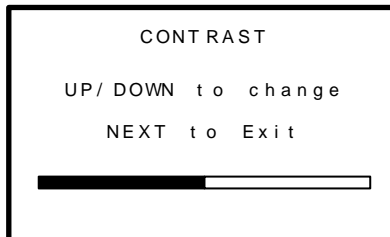

Figure 8-5 LCD Contrast Adjust Menu

8.5 TURN POWER OFF

There are three ways to power down the SENSICAST TRANSMITTER. Use this menu in the DEVICE SETUP group, or, with any **Data Display** on the screen hold the NEXT key for several seconds. The final way, which should only be used if the unit is not responding to any key swipes, is to hold the EDIT key until the unit powers down. Power should be turned off prior to replacing the battery. Otherwise, a large storage capacitor will keep the SENSICAST TRANSMITTER powered for up to 10 minutes even after the battery is removed.

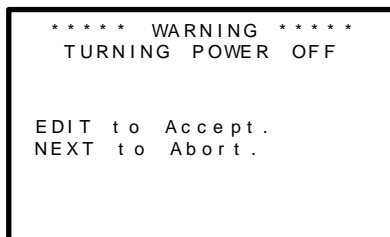

Figure 8-6 Turn Power OFF Menu

8.6 RESET RANGE ICON

The **Reset Range Icon** menu only appears if the SENSCAST TRANSMITTER has experienced an Out-of-Range (📶) condition, but later recovered to achieve Server In-Range status. In this case, the SENSCAST TRANSMITTER latches the Server Previously Out-of-Range condition and displays the associated icon (📶) on readouts to indicate a potential problem with communications to this SENSCAST TRANSMITTER. It is important to Reset the unit back to the desired Server In-Range icon (📶) either by using this menu or by cycling SENSCAST TRANSMITTER power.

Following is a description how to use the range icons as wireless network troubleshooting tools:

The SENSCAST TRANSMITTER displays one of three RANGE ICONS (📶,📶,📶) to indicate if its radio has been achieving the Server In-Range status necessary to broadcast its data.

- 📶 is desired since it indicates **every** attempt to broadcast since power up has been successful.
- 📶 indicates, during the **most recent** attempt, the Server could not be found.
- 📶 indicates the most recent attempt was successful, however, an earlier attempt was unsuccessful.

If the SENSCAST CONTROLLER is experiencing comm errors there are two probable causes:

1. The SENSCAST TRANSMITTER is not achieving “Server In-Range” status and therefore not broadcasting.
2. The SENSCAST TRANSMITTER broadcasts but the data is not received by the SENSCAST CONTROLLER.

SENSCAST TRANSMITTER range icons help isolate #1 or #2 since if the desired 📶 is displayed, #2 must be the problem. However, if intermittent SENSCAST CONTROLLER comm errors occur, and 📶 is displayed it is likely the SENSCAST TRANSMITTER is not reliably achieving a Server In-Range status.

SENSCAST RECEIVER

Chapter 9 - SENSCAST RECEIVER DESCRIPTION

9.1 SENSCAST RECEIVER DESCRIPTION

The Sensidyne, LP Co. Inc. 32 Channel SensCast Receiver is designed to display readings and control alarm event relay switching for up to 32 SensCast Monitors. The SENSCAST CONTROLLER receives Fail, Alarm 1, Alarm 2, Alarm 3 and Low Battery signals from each SENSCAST TRANSMITTER, maps them to its 8 programmable relays, while adding features such as Latching / Failsafe, Alarm Acknowledge and Refresh. A piezo driver circuit for a local audible annunciator may also be mapped to the relays. Eight standard 5-amp alarm relays may be programmed to activate based upon various alarm combinations and channel zoning. A Real-Time Clock and Calendar are also standard.

An optional 299-0085-01 Multi-Function module (see [Chapter 13](#)) may be integrated into any of the standard SENSCAST CONTROLLER enclosures to add data logging, a wired or wireless Modbus slave port, plus a Wi-Fi port with web-server. The Wi-Fi feature allows remote HMI functionality via any web enabled device. This means the SensCast Receiver allows responders to view real time and historical data on smart phones, tablets and PCs prior to entering a potentially hazardous area.

A backlit 128 x 64 pixel graphic LCD shows monitored data as bar graphs and engineering units. System configuration is via user friendly menus, and all configuration data is retained in non-volatile memory during power interruptions. The SENSCAST CONTROLLER front panel is shown below in Figure 9-1 displaying the Eunit/Bar Graph data screen. The five button symbols below the display may be magnetically activated using the supplied magnetic wand without opening the enclosure. Opening the enclosure door provides access to the push button keypad as shown in Figure 9-2.

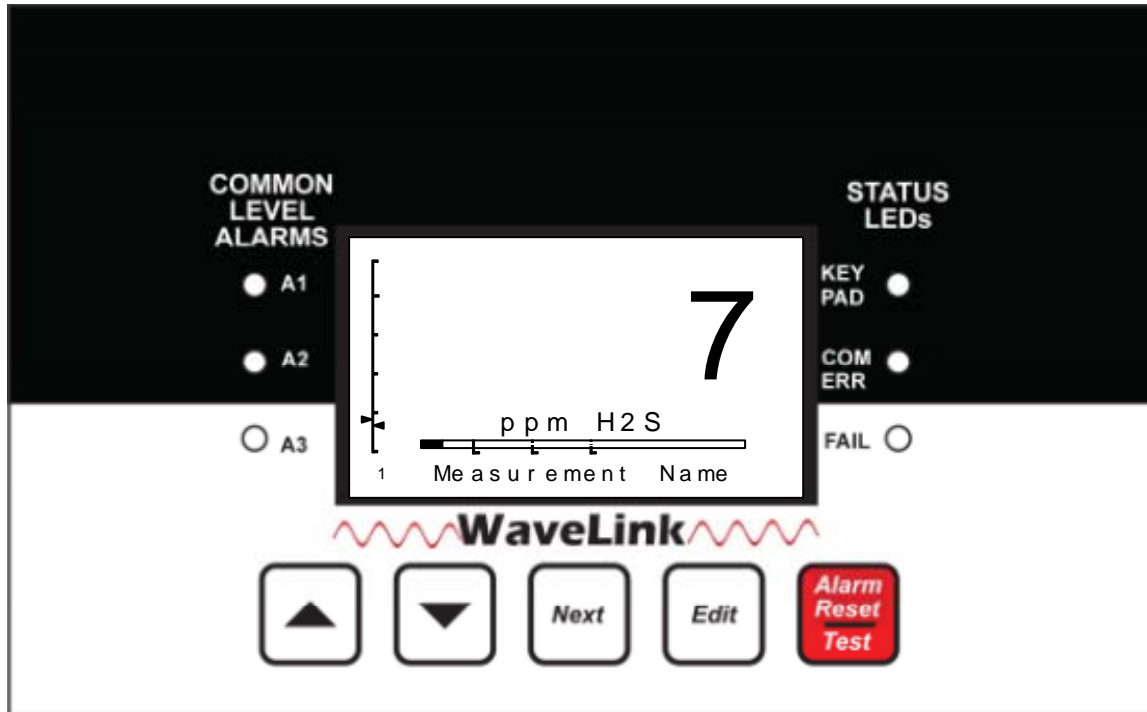

Figure 9-1 SENSICAST CONTROLLER Front Panel

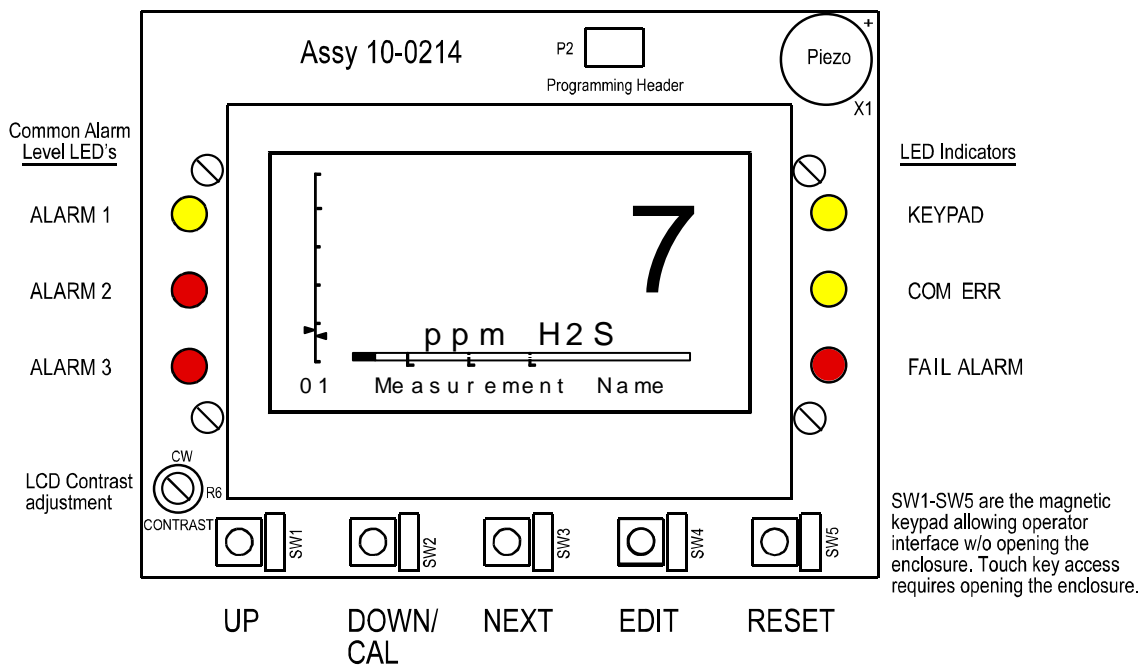

Figure 9-2 299-0066-01 SENSICAST CONTROLLER Display PCB

9.2 DATA DISPLAY SCREENS

When there are no channels with alarm conditions the SENSICAST CONTROLLER displays **ALARMS STATUS CLEAR** as the main readout screen. However, pressing the **NEXT** key displays the **Event Log** screen which displays various status changing events as discussed in [Section 10.9](#). Pressing **NEXT** again displays the **Eunits/Bar Graph** screen shown in Figure 9-3, which allows scrolling past all active channels with the UP/DOWN keys. This is very useful for observing incoming SENSICAST TRANSMITTER broadcasts one channel at a time. When there are channels with alarms, the **ALARMS STATUS CLEAR** screen is replaced by the **Channel Alarm Status** screen which displays any active channel in alarm, and followed by an alternating line which shows the channel's Measurement Name and the current alarm. The **EUNIT/Bar Graph** screen is also available during alarm conditions.

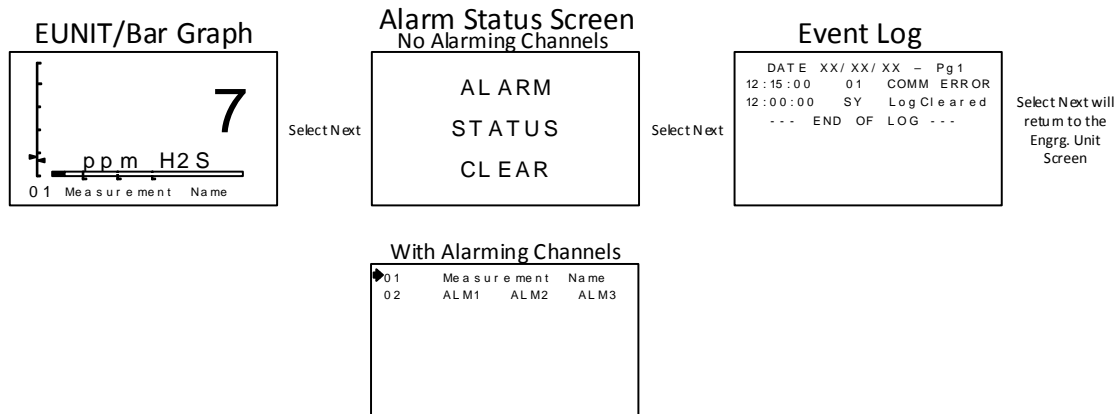

Figure 9-3 SENSICAST CONTROLLER Data Displays

9.2.1 EUNIT/BAR GRAPH SCREEN AND COMM ERROR TIME LINE

The SENSICAST CONTROLLER EUNIT/Bar Graph screen in Figure 9.4 consists of:

- Large digital value with Engineering Units
- Horizontal bar graph with A1, A2 and A3 levels indicated across the bar
- 16 character **Measurement Name** field for user ID of this SENSICAST TRANSMITTER's location
- The crucial Vertical **Comm Error Time Line** on the left edge of the screen

The UP/DOWN keys scroll this screen through all active channels one at a time.

The vertical Comm Error Time Line on the far left of this screen is divided into five segments, from bottom to top. Each segment equals one SENSICAST TRANSMITTER Wakeup Timer interval from the SENSICAST TRANSMITTER providing data to this SENSICAST CONTROLLER channel (see [Section 8.1.3](#)). Therefore, the entire time line is equal to 5 times the Wakeup Timer value.

The arrow on the right side of the Time Line slides up the line as time goes by for the current channel being observed. However, every time the SENSICAST TRANSMITTER broadcast packet is received on this channel, the pointer resets to the bottom of the time line. If the pointer reaches the top of the time line the SENSICAST CONTROLLER will raise a comm error for this channel. For example, if the Wakeup Timer is set for the maximum 5 minutes it requires 25 minutes without a broadcast to raise the Comm Error alarm for the channel. If the wireless link between the SENSICAST TRANSMITTER and this channel is functioning properly the pointer should never exceed the 1st Wakeup Timer line segment.

The arrow on the left side of the Time Line slides up the line as time goes by in a similar manner to the other arrow. However, this pointer represents the channel which is furthest along its time line for all of the monitored

channels. This is useful in determining if any channels have missed a transmission without having to cycle through observing all of the channels. If the arrow on the left hand side has not passed the first segment, all of the monitored channels have received their latest transmission.

EUNIT/Bar Graph Screen

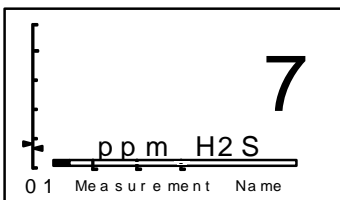

The EUNIT/Bar Graph screen has flashing alarm icons for A1, A2,A3 FL (fail). Menu Item in System Menu controls if these readings display or block negative values. Number in bottom left indicates the channel currently being displayed. Use UP/DOWN to cycle through channels to be displayed. The vertical Comm Error Time Line on the far left of this screen is divided into five segments, from bottom to top. Each segment equals one WCM Wakeup Timer interval from the WCM providing data to this WLR channel (Section 8.1.3). Therefore, the entire time line is equal to 5 times the Wakeup Timer value. The arrow on the right side of the line slides up the line as time goes by. However, every time the WCM broadcast packet is received on this channel, the pointer resets to the bottom of the time line. IF THE POINTER REACHES THE TOP OF THE TIME LINE THE WLR RAISES A COMM ERROR ALARM FOR THIS CHANNEL. The arrow on the left hand side represents the channel furthest along its Time Line for all of the monitored channels.

Figure 9-4 EUNIT/Bar Graph Screen

9.2.2 ALARMS STATUS CLEAR SCREEN

The **ALARMS STATUS CLEAR** screen indicates there are no alarm conditions among the active channels and the SensCast Monitoring System is performing normally. The **NEXT** key moves from this screen to the **Event Log** screen.

9.2.3 CHANNEL ALARM STATUS SCREEN

The Channel Alarm Status screen shows all active channel numbers, but causes any with an alarm condition to flash. Use the UP/DOWN keys to point to a channel in alarm and the EDIT brings up that channel's EUNIT/Bar Graph screen to provide more detailed information about the alarm. The pointer will automatically go to the first alarming channel when entering this screen.

If no Channel is in an alarm state this screen will not be displayed, and the Alarms Status Clear screen will be displayed in its place.

9.2.4 EVENT LOG SCREEN

The **Event Log** screen shows time and date stamped alarm events in a first in first out 99 event buffer. The **Clear Event Log** menu allows erasing of all events. The **Event Log** displays several different types of events:

1. Comm Error in and clear
2. Alarms in and clear
3. Relays energized and de-energized
4. Low battery
5. Calibration Mode
6. Warm up
7. Power up

8. Local acknowledge
9. Cold Boot
10. RMT Ready
11. Network Configuration
12. Disabled
13. RMT Initialization
14. System locked and unlocked
15. Log Cleared
16. Push to Test
17. Remote acknowledge
18. Remote Configuration
19. Missing sensor
20. Relay Configuration

When one of the previous events occurs a new line will be displayed on the **Event Log** showing the time of the occurrence, the channel it occurred on (or SY if it is a system occurrence) and the type of event. For more detailed information refer to [Section 10.9](#).

Event Log

```
DATE XX/XX/XX - Pg 1
12:15:00 01 COMM ERROR
12:11:00 SY LogCleared
--- END OF LOG ---
```

Figure 9-5 Event Log Screen

9.3 SPECIFICATIONS

9.3.1 POWER SUPPLY REQUIREMENTS

SENSCAST CONTROLLER primary power may be either 10-30 VDC or 100-240VAC. AC power requirements are 100-240 VAC 50/60 Hz @ .80 amp max (including inrush) and 40 watts max steady state, applied to TB5 on the motherboard. If AC power is not available the primary power may be 10-30 VDC applied to TB1 on the motherboard, which is very useful for 12VDC solar powered installations. A back-up DC power source may also be connected to TB1 for automatic switchover if the AC power source fails. See Figures 11-1 and 11-2 for wiring information.

The basic SENSCAST CONTROLLER consumes only 3.0 watts of 10-30 VDC power (all relays energized). Optional features increase power consumption as described below:

With an AC primary power source connected to TB1 on the motherboard, TB3 terminals 1 and 2 on the motherboard provide a maximum of 10 watts output power for powering auxiliary external devices such as relays, lights and monitors (see Figure 11-1). Power consumed from TB3 must be included when calculating system power consumption.

IMPORTANT! TB3 only provides 24VDC power when AC is primary power.

Some applications may require 24VDC power in excess of the 10 watts available from the SENSCAST CONTROLLER Motherboard power supply. An optional 50 watt 299-0044-01 DIN rail AC/DC supply is available to increase 24VDC power (see [Section 11.3](#)).

9.3.2 RELAYS

The 8 standard Form C dry contact relays are functionally equivalent but 2 are on the 299-0067-01 Motherboard (see Figure 11-2) and 6 are on the 299-0068-01 Relay PCB (see Figure 11-3). Relays may be mapped to various alarm events as described in [Section 10.6.1](#).



All mechanical (dry contact) relays are rated at 5 Amp for 28 VDC and 250 ~VAC **RESISTIVE** loads. **IMPORTANT:** Appropriate diode (DC loads) or MOV (AC loads) snubber devices should be installed with inductive loads to prevent RFI noise spikes.

9.3.3 AMBIENT TEMPERATURE RANGE

-25 to 60 degrees C

9.3.4 HUMIDITY RANGE

0 TO 90% R. H. Non-Condensing.

9.3.5 ALTITUDE

Recommended up to 2000 meters

9.3.6 HOUSINGS / INSTALLATION CATEGORIES

- SENSCAST CONTROLLER/PY *NEMA 4X non-metallic polyester wall mount. DIV 2 Groups A,B,C,D; Category II and pollution degree 3; NEMA 4X; IP66
- SENSCAST CONTROLLER/PCS *NEMA 4 painted carbon steel wall mount. DIV 2 Groups A,B,C,D; Category II and pollution degree 3; NEMA 4; IP66
- SENSCAST CONTROLLER/SS *NEMA 4X stainless steel wall mount. DIV 2 Groups A,B,C,D; Category II and pollution degree 3; NEMA 4X; IP66
- SENSCAST CONTROLLER/XP *NEMA 7 wall mount for DIV 1 & 2 Groups B, C, D; includes 'O' Ring in door to satisfy NEMA 4 rating.

*Includes standard non-intrusive magnetic keypad.

9.3.7 APPROVALS (PENDING)

Chapter 10 – SENSCAST RECEIVER OPERATION

10.1 OPERATOR INTERFACE

The SensCast Receiver's graphic LCD and 5-button keypad serves as its operator interface. All SENSCAST CONTROLLER configuration parameters are entered with this operator interface using SETUP menus accessed by pressing EDIT from any data display screen. This Setup mode may be exited manually by pressing NEXT, or automatically when no keys are pressed for 5 minutes. Alarm relays and front panel alarm LED indicators remain active during the Setup mode. A SECURITY menu offers a password feature to prevent tampering with SENSCAST CONTROLLER menus.

SENSCAST CONTROLLERS only display the readings and alarm events which are created at the SensCast Monitor. No Channel Alarm decision making occurs inside the SENSCAST CONTROLLER.

10.2 SETUP MENU CONFIGURATION

Variables in the **Channel** (see [Section 10.5](#)) and **System** (see [Section 10.6](#)) menus allow SENSCAST CONTROLLER configuration for a wide range of monitoring applications. Select the desired menu by scrolling with UP/DOWN and then EDIT to enter each menu. **Channel** menus affect only the specific channel selected while **System** menus are related to features not specific to any channel.

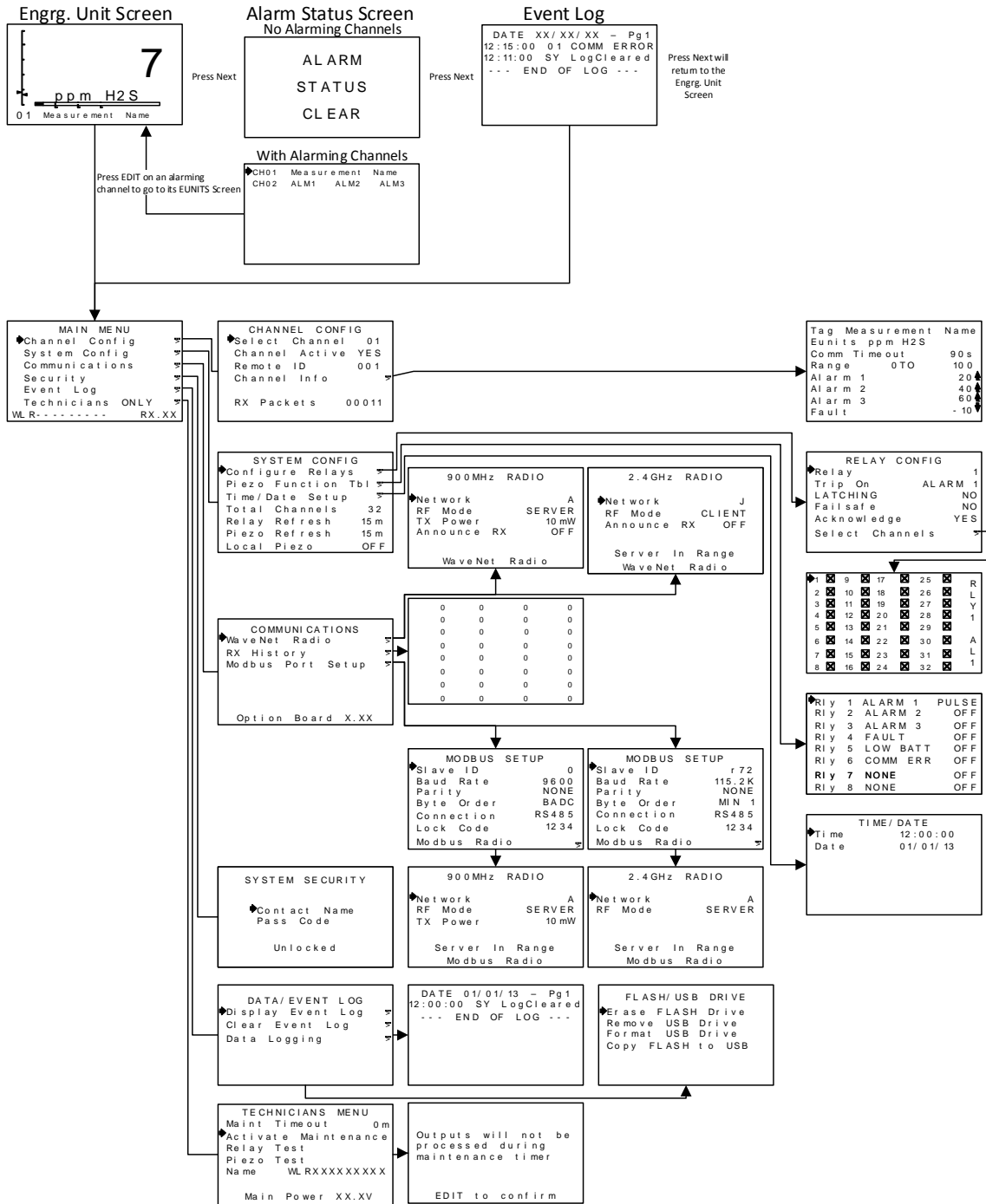

Figure 10-1 SENSICAST CONTROLLER Menu Tree

10.3 CHANGING MENU VARIABLES USING THE KEYPAD

After entering the menu a pointer controlled by the UP/DOWN keys indicates the selected variable. Some are simple YES/NO or ON/OFF entries toggled by pressing the EDIT key. Others have many ASCII character possibilities. Allowed ASCII characters are as follows: ABCDEFGHIJKLMNOPQRSTUVWXYZ [] ^ _ ` abcdefghijklmnopqrstuvwxyz blank space ! " # \$ % & ' () * + , - . / 0 1 2 3 4 5 6 7 8 9 ; : < = > ? @. Notice the often used *blank* character is located after lower case

z and before the exclamation point (!). EDIT places a cursor under the item and UP/DOWN scrolls through each allowed entry. The NEXT key moves the cursor to the next position within a field. When the field is complete, EDIT clears the cursor and loads the field into non-volatile memory where it is retained indefinitely. Without a cursor present, the NEXT key closes open menus in reverse order and returns the LCD to the data display.

10.4 SENSICAST CONTROLLER MAIN MENU

The MAIN MENU group shown in Figure 10-2 below is reached by pressing EDIT with any data display present. This is the entry-level screen to **Channel Config**, **System Config**, **Communications**, **Security**, **Event Log** and **Technicians ONLY** menus. It also shows the serial number and firmware revision operating in the SENSICAST CONTROLLER. Use the UP/DOWN keys to move the pointer to the desired menu and press the EDIT key.

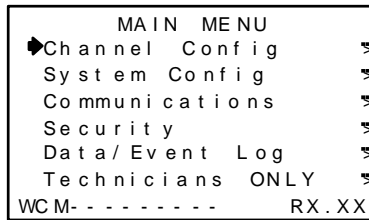

Figure 10-2 SENSICAST CONTROLLER Main Menu

10.5 CHANNEL CONFIG MENU GROUP

The **CHANNEL CONFIG** menu shown in Figure 10-3 allows configuration of variables specific to the selected channel. The channel to be affected is selected by pressing the **EDIT** key.

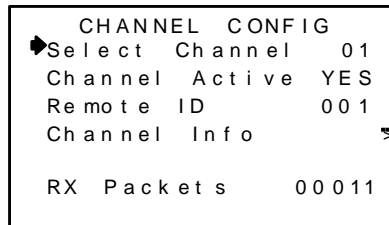

Figure 10-3 SENSICAST CONTROLLER Channel Config Menu

10.5.1 CHANNEL ACTIVE

Channel Active is a YES/NO field that allows temporarily deactivating channels. Channels that may be deactivated are limited to the number of **Total Channels** designated in the System Config menu group (see [Section 10.6.4](#)). If a channel is to be permanently removed then **Total Channels** should be adjusted down to reflect the number of SENSICAST TRANSMITTERs communicating to this SENSICAST CONTROLLER.

10.5.2 REMOTE ADDRESS

The **Remote Address** menu determines which SENSICAST TRANSMITTER RTU number is assigned to this SENSICAST CONTROLLER channel. RTU numbers are limited to 1-32 but any of these may be assigned to any of the 32 SENSICAST CONTROLLER channels. This is useful for arranging which SENSICAST CONTROLLER channels are used to display specific SENSICAST TRANSMITTERs. For example, dual gas SENSICAST TRANSMITTERs have consecutive RTU numbers. It might be desirable to separate these at the SENSICAST CONTROLLER in order to keep same gas types together on its readout.

10.5.3 CHANNEL INFO

It is important to understand that all **CHANNEL INFO** data is received from the SENSICAST TRANSMITTER. It is broadcast to the SENSICAST CONTROLLER at every SENSICAST TRANSMITTER power up, channel edit and routinely upon expiration of the **TX Config Timer** described in [Section 8.1.5](#). Modification of the parameters on this screen may only be done at the SENSICAST TRANSMITTER broadcasting to this channel.

10.5.4 RX PACKETS

RX Packets displayed at the bottom of the **CHANNEL CONFIG** screen is a counter incremented each time a new data packet is received from the SENSICAST TRANSMITTER. It may be reset to zero at the **RX HISTORY** screen in the **COMMUNICATIONS** menu group by pressing the **Alarm Reset** button (see [Section 10.7.3](#)).

10.5.5 BATT 3.6V

The battery voltage of the SENSICAST TRANSMITTER broadcasting to this channel is also displayed at the bottom of the **CHANNEL CONFIG** screen. The nominal value is 3.6 volts, and SENSICAST TRANSMITTERs trip their **Low Batt** alarm at < 3.3 volts.

10.6 SYSTEM CONFIG MENUS

The **SYSTEM CONFIG** menus shown in Figure 10-4 allows configuration of variables for the SENSICAST CONTROLLER unrelated to any specific channel. This includes programming how the relays and audible piezos function, total number of channels and time / date.

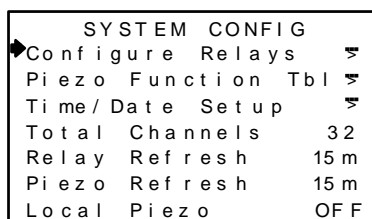

SYSTEM CONFIG		
Configure Relays		M
Piezo Function Tbl		M
Time/Date Setup		M
Total Channels	32	
Relay Refresh	15 m	
Piezo Refresh	15 m	
Local Piezo	OFF	

Figure 10-4 SENSICAST CONTROLLER System Config Menu

10.6.1 CONFIGURE RELAYS

The **RELAY CONFIG** screen shown in Figure 10-5 allows sophisticated programming of each of the eight relays. Select the relay to be configured by pointing to the Relay menu and pressing EDIT.

- **Trip On** controls what conditions will cause the relay to activate. These may be
 - **A1**
 - **A2**
 - **A3**
 - **Fault**
 - **Low Battery** (from a SENSICAST TRANSMITTER)
 - **Comm Error**
 - **Remote Edit** (someone is modifying the SENSICAST TRANSMITTER's settings)
 - **Channel Disable** (a SENSICAST CONTROLLER channel has been disabled by an operator)
 - **None** (this relay is not used and will never activate).

- **Latching** determines either manual or automatic alarm reset operation. **YES** requires a manual Alarm Reset button press to unlatch the relay even though an alarm condition no longer exists. **NO** allows this relay to automatically reset after the alarm condition clears.
- **Failsafe** is an ON/OFF field where ON causes the relay to energize when the condition is not present. When the **Trip On** condition becomes true the relay de-energizes. **Failsafe** is often utilized when it is desirable for loss of power to indicate the alarm condition.
- **Acknowledge** is an ON/OFF field with ON typically used when the relay controls an audible device and it is desirable to silence the horn audible while troubleshooting the alarm. Applying an Alarm Reset causes the relay to return to its inactive state even though the alarm condition remains in effect. The **Relay Refresh** menu (see [Section 10.6.5](#)) may be used to re-activate acknowledged relays.
- **Select Channels** brings up a check box (Figure 10-6) screen for assigning which of the Active Channels are assigned to this relay. This allows creating Zones among the active channels.

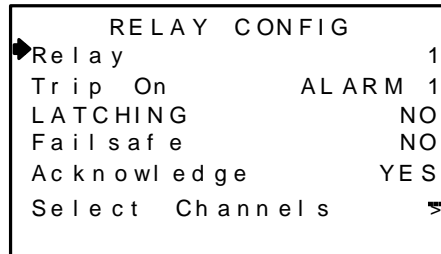

Figure 10-5 Configure Relays Menu

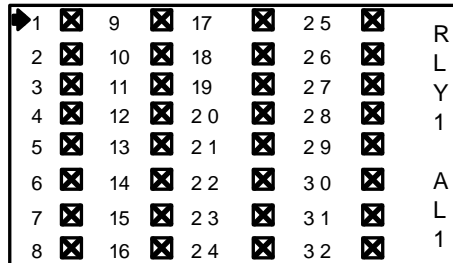

Figure 10-6 Select Channels Screen

10.6.2 PIEZO FUNCTION

The **Piezo FUNCTION** group determines behavior of the optional (part#10-0337) 100dB locally mounted piezo, related to the eight relays. Choices are **OFF**, **Chirp**, **Pulse** and **Steady**. For example, an A1 condition might be configured to **Pulse** the piezo while an A2 condition causes it to be **Steady**.

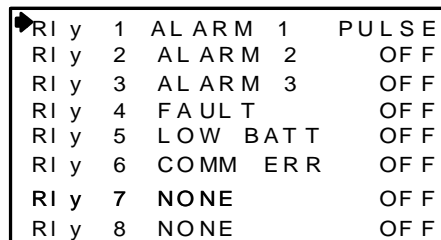

Figure 10-7 Piezo Functions

10.6.3 TIME/DATE SETUP

The **Time** and **Date** menus are for setting the correct time and date of the 24-hour clock and calendar. Time of day must be entered in 24 hour mode. For example, 6:00:00 PM is indicated as 18:00:00.

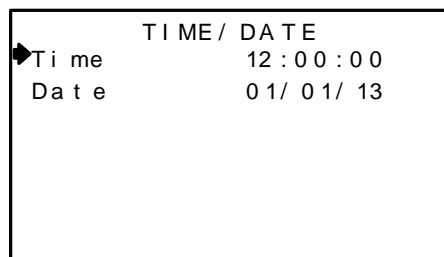

Figure 10-8 Time/Date Menu

10.6.4 TOTAL CHANNELS

Total Channels may be 1-32 and limits the maximum number of active channels. For example, if this menu is set for 10, then only 10 channels are available in the CHANNEL CONFIG menus discussed in [Section 10.5.1](#).

10.6.5 RELAY REFRESH

Relay Refresh may be set from 0-120 minutes with 0 turning the Refresh function OFF. Each relay may be set to allow **Acknowledge** (see [Section 10.6.1](#)) which means an **Alarm Reset** deactivates the relay even though the alarm condition still exists. **Refresh** will re-activate the relay after this timer expires. This feature is useful for silencing audible devices, and then automatically activating them again if the alarm condition remains after a period of time.

10.6.6 PIEZO REFRESH

Piezo Refresh functions similarly to the **Relay Refresh** ([Section 10.6.5](#)). However, it may only be set from 1 to 60 minutes, and may not be turned OFF. **Piezo Refresh** only affects the optional (part#10-0337) 100dB locally mounted piezo, which connects to the Audible Alarm connector on the Motherboard (see Figure 11-2). This piezo is always Acknowledgeable.

10.6.7 LOCAL PIEZO

Local Piezo is an ON/OFF field where ON causes the tiny piezo on the SENSICAST CONTROLLER's 299-0066-01 SENSICAST CONTROLLER Display PCB to mimic the larger piezo (part#10-0337) wired to the Motherboard. This can be useful for testing operation of the louder device even though it is disconnected. The Local Piezo always chirps as keys are depressed.

10.7 COMMUNICATIONS

The **Communications / SENSICAST Radio** menus shown below in Figure 10-9 allow setting Network ID, Server / Client and viewing a history of how many successful wireless messages have been received by each channel. Figure 10-10 shows the SensCast Radio Menus for both operating frequencies.



Figure 10-9 Communication Menus

10.7.1 SENSICAST RADIO

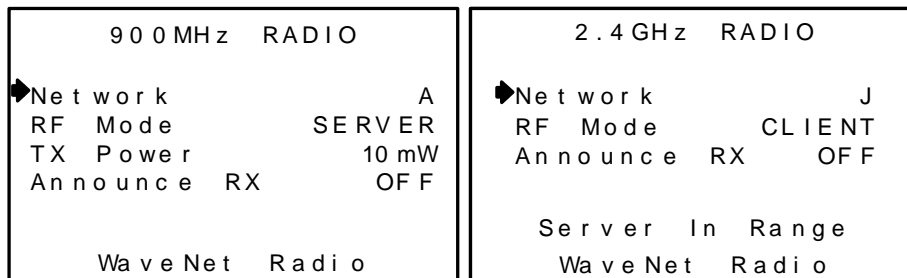

Figure 10-10 SENSICAST Radio Menus

10.7.1.1 NETWORK

SensCast devices utilize the **Network** setting to assign up to 26 unique hopping patterns. To simplify system setup, **Network** is entered using letter designators A through Z where A = [Hop Channel 1, System ID 1] and Z = [Hop Channel 26, System ID 26]. A SENSICAST TRANSMITTER will not indicate Server In-Range status or communicate with any SensCast Relayer operating on a different **Network**. This feature allows multiple SensCast wireless systems to be located within range of each other without interference.

Networks M through Z are encrypted networks. When one of these networks is selected the data will be encrypted via proprietary methods to ensure that only devices on that network which hold the encryption key will be able to decipher the data being transmitted.

2.4GHZ used in EU countries: Hop channels on 2.4 GHZ models may be set between 1 and 26. Hop channels A-R include EU “low band” frequencies 2406 – 2435MHZ. Hop channels S-Z include EU “high band” frequencies 2444 – 2483.5MHZ.

IMPORTANT!! EXPLORE WHAT FREQUENCIES ARE APPROPRIATE FOR THE FINAL LOCATION OF ANY WIRELESS SYSTEM.

10.7.1.2 RF MODE

RF Mode determines if the SENSICAST CONTROLLER is a Server or a Client. ONLY ONE SERVER IS ALLOWED PER WIRELESS NETWORK ID. Numerous SENSICAST CONTROLLERS may share the same Network ID but only one may be the Server. Networks with multiple SENSICAST CONTROLLERS should have the most centrally located unit designated as the Server (see [Section 2.2](#)).

10.7.1.3 TX POWER

The **TX Power** menu is only available on 900MHz systems, and allows the setting of the **TX Power** for the radio. The settings for this are 10mW, 200mW, 400mW and 1W.

2.4GHZ variation: The TX Power menu is not available in 2.4GHZ models and is fixed at 125mW conducted.

10.7.2 RX HISTORY

RX History is provided as a wireless network diagnostics tool. It simply counts how many broadcasts are received by each channel. It always displays 32 channels regardless of how many active channels the SENSICAST CONTROLLER is configured for currently. All 32 totals may be reset to zero by entering the screen and pressing the Alarm Reset key.

0000	0000	0000	0000
0000	0000	0000	0000
0000	0000	0000	0000
0000	0000	0000	0000
0000	0000	0000	0000
0000	0000	0000	0000
0000	0000	0000	0000
0000	0000	0000	0000
0000	0000	0000	0000

Figure 10-11 RX History

10.8 SECURITY

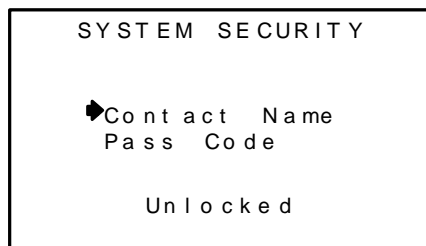

Figure 10-12 Security Menu

The **SECURITY** menu in Figure 10-13 requires the 4-digit **Pass Code** prior to altering menus. Entering a Pass Code and locking the menu locks the entire menu database until the correct **Pass Code** is entered. **Contact Name** is a 12 character ASCII field available for displaying a phone # or name of personal who know the **Pass Code**. Lost **Pass Codes** may be recovered by entering the locked security menu and holding the UP key for 5 seconds. The 4-digit code appears near the bottom of the screen.

10.9 DATA/EVENT LOG

10.9.1 EVENT LOG

The **Display Event Log** pages show time and date stamped alarm events in a first in first out 99 event buffer. The **Clear Event Log** menu allows erasing of all events.

The **Display Event Log** displays several different types of events:

Event	Abbreviation
1 Communication Error in and clear	COMM ERROR, COMM OK
2 Alarms in and clear	Alarm1 IN, Alarm2 IN, Alarm 3 IN, Fault IN, Alarm1 OUT, Alarm2 OUT, Alarm3 OUT, Fault OUT
3 Relays energized and de-energized	Relay1 CLR, Relay2 CLR, Relay3 CLR, Relay4 CLR, Relay5 CLR, Relay6 CLR, Relay7 CLR, Relay8 CLR, Relay1 SET, Relay2 SET, Relay3 SET, Relay4 SET, Relay5 SET, Relay6 SET, Relay7 SET, Relay8 SET
4 Low battery	LOW BAT
5 Cal Mode	CAL MODE
6 Warm up	WARM UP
7 Power up	POWER UP
8 Local acknowledge	LOCAL ACK
9 Cold Boot	COLD BOOT
10 RMT Ready	RMT READY
11 Net Configuration	NET CONFIG
12 Disabled	DISABLED
13 RMT Initialization	RMT INIT
14 System locked and unlocked	SYS LOCKED, UNLOCKED
15 Log Cleared	LogCleared
16 Push to Test	PushToTest
17 Remote acknowledge	Remote ACK
18 Remote Configuration	RMT CONFIG
19 Missing sensor	MIS SENSOR
20 Relay Configuration	RLY CONFIG

```

DATE 01/01/13 - Pg 1
12:00:00 SY LogCleared
- - - END OF LOG - - -
    
```

Figure 10-13 Display Event Log Pages

10.9.2 DATA LOG(OPTIONAL)

When the optional 299-0085-01 Multi-Function Board with Data Logging Capabilities is installed, this menu (Figure 10-15) is available, and performs the following functions:

1. **Erase FLASH drive** – Erases the onboard FLASH of the Multifunction Board
2. **Remove USB drive** – Allows safe removal of any attached USB drive
3. **Format USB drive** – Reformats any attached USB drive
4. **Copy FLASH to USB** – Copies the information from the onboard FLASH memory to any installed USB drive

For a more detailed description of the Data Logging capabilities of the 299-0085-01 Multi-Function Option Board refer to [Chapter 13](#).

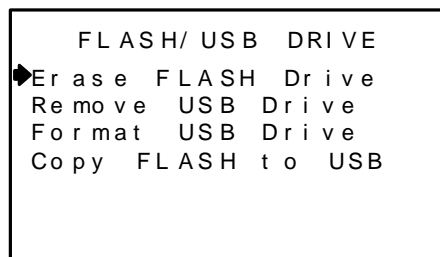

Figure 10-14 Flash/USB Drive Menu

10.10 TECHNICIANS ONLY

WARNING! Users of this menu must have a detailed understanding of its function.

The **TECHNICIAN** Menu in Figure 10-15 **requires a special key sequence of four consecutive UP keystrokes** to access, in order to prevent accidental modification of these items.

Maint Timeout and **Activate Maintenance** are options designed specifically to work together. By selecting **Activate Maintenance** all alarms will not be processed and relays are disabled. **Maint Timeout** allows a timer to be set which causes maintenance mode to be exited after a specified amount of time has passed. This is very helpful in preventing inadvertently disabling alarms for extended periods of time.

Relay Test allows each of the 8 relays to be energized manually. This is helpful for ensuring relays are set up properly. The **Piezo Test** cycles the Piezo on and off when selected until another key is selected.

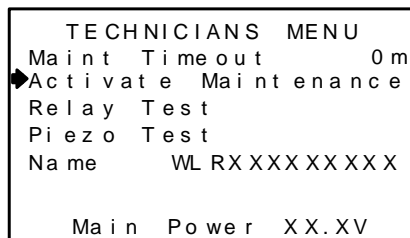

Figure 10-15 Technicians Only Pages

Chapter 11 – SENSCAST RECEIVER PCBs

11.1 MOTHERBOARD INTERFACE PCB # 299-0067-01

The SENSCAST CONTROLLER Motherboard shown below in Figure 11-2 is the interface between the Display / CPU assembly and all other system I/O devices. The Display / CPU assembly attaches to the motherboard with 4-standoffs and connects via ribbon cable to S1. The optional 299-0085-01 Multi-Function option plugs into the P1 and P2 Motherboard option connectors. The P3 connector on the right side is for the 299-0068-01 Relay PCB.

The Motherboard PCB contains a 24 VDC universal input (100-240 VAC) switching power supply with up to 350mA available at the TB3 Auxiliary Power Output terminals. If AC power is unavailable, or if a DC battery back-up supply needs to be connected, TB1 provides terminals for DC power input. Blocking diodes isolate internal and external DC supplies as shown in Figure 11-1. See [Section 9.3.1](#) for additional power source information.

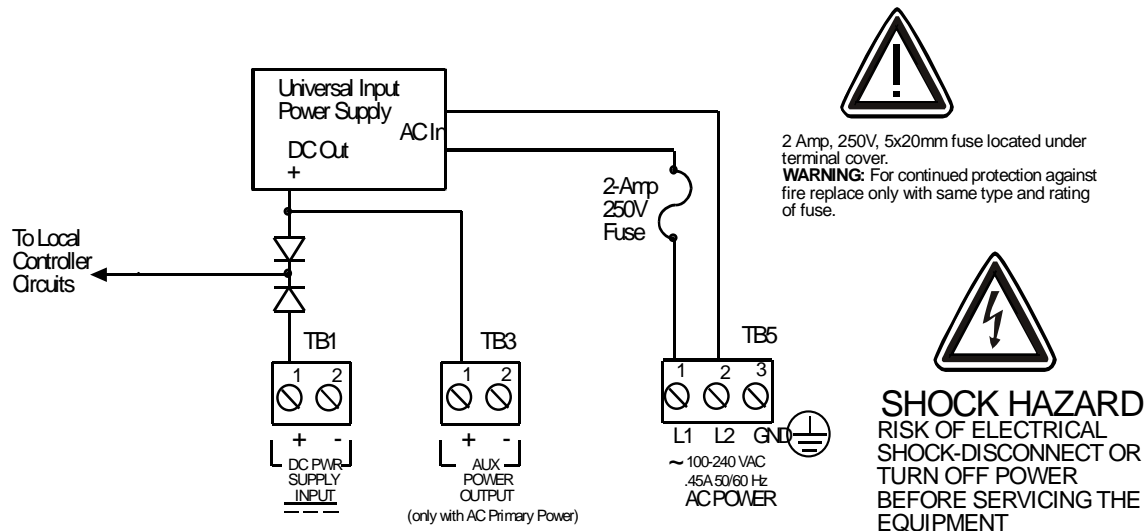
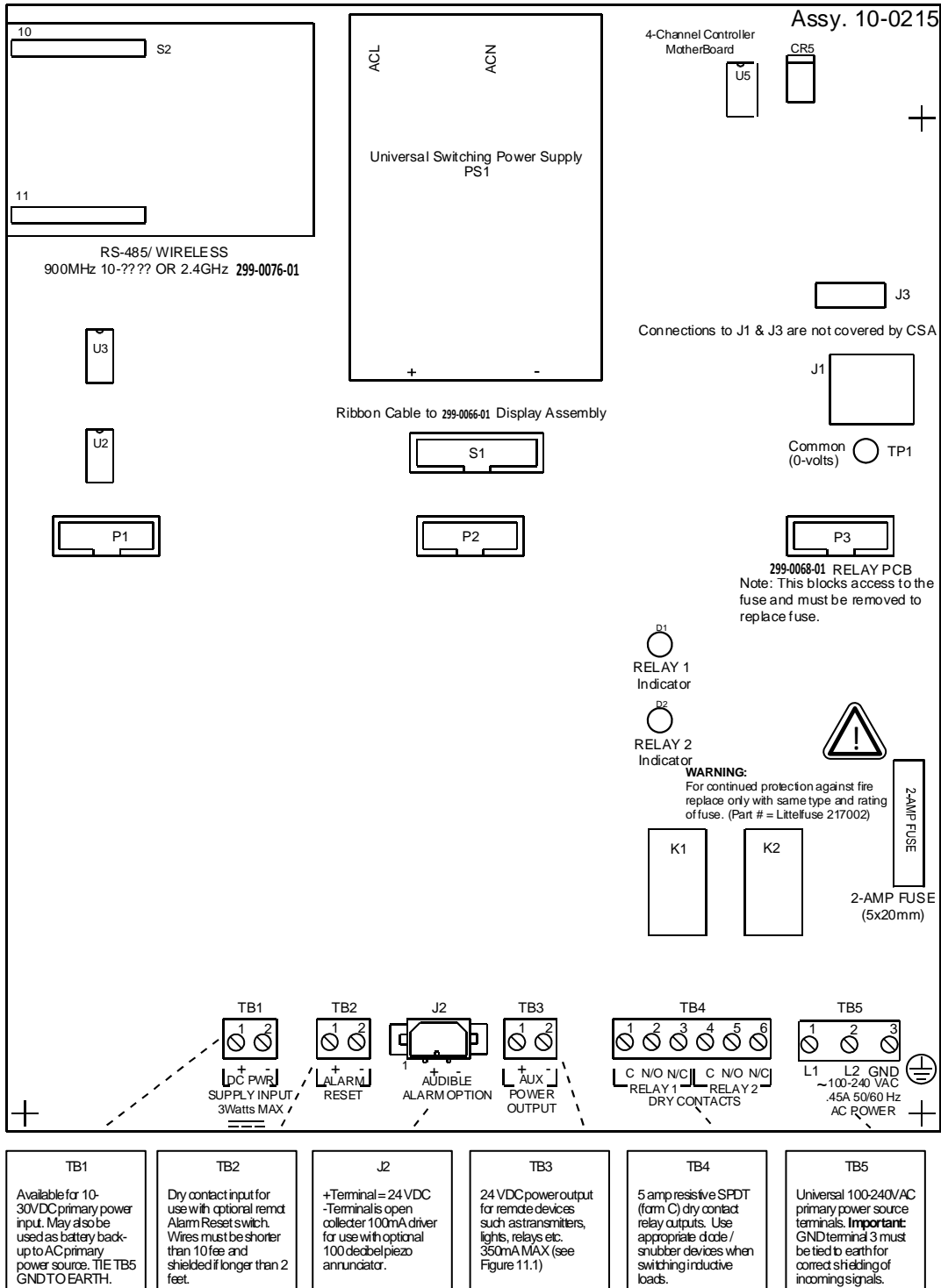

Figure 11-1 AC/DC Power Schematic

TB2 offers field terminals for a remote alarm reset switch. The Motherboard also includes alarm relays 1 and 2 (K1 and K2) and their indicating LEDs. TB4 provides field wiring terminals for these relays. TB5 is for connection to the 100-240 VAC power source. J2 is a 2-pin connector for powering the optional part # 10-0337 100dB audible annunciator.



<p>TB1</p> <p>Available for 10-30VDC primary power input. May also be used as battery back-up to AC primary power source. TIE TB5 GND TO EARTH.</p>	<p>TB2</p> <p>Dry contact input for use with optional remote Alarm Reset switch. Wires must be shorter than 10 feet and shielded if longer than 2 feet.</p>	<p>J2</p> <p>+Terminal = 24VDC -Terminal is open collector 100mA driver for use with optional 100 decibel piezo annunciator.</p>	<p>TB3</p> <p>24VDC power output for remote devices such as transmitters, lights, relays etc. 350mA MAX (see Figure 11.1)</p>	<p>TB4</p> <p>5 amp resistive SPDT (form C) dry contact relay outputs. Use appropriate diode/snubber devices when switching inductive loads.</p>	<p>TB5</p> <p>Universal 100-240VAC primary power source terminals. Important: GND terminal 3 must be tied to earth for correct shielding of incoming signals.</p>
------------------------------------------------------------------------------------------------------------------------------------------------------------	--------------------------------------------------------------------------------------------------------------------------------------------------------------------	---------------------------------------------------------------------------------------------------------------------------------------------	--------------------------------------------------------------------------------------------------------------------------------------	---------------------------------------------------------------------------------------------------------------------------------------------------------	---------------------------------------------------------------------------------------------------------------------------------------------------------------------------------

SHOCK HAZARD
RISK OF ELECTRICAL SHOCK-DISCONNECT OR TURN OFF POWER BEFORE SERVICING THE EQUIPMENT



Figure 11-2 299-0067-01 Motherboard

11.2 RELAY PCB # 299-0068-01

Important! 299-0068-01 PCB may only be installed into motherboard position P3.

The Relay PCB, shown in Figure 11-3, adds six 5 amp form C relays. Each relay is programmable as described in [Section 10.6.1](#).



All mechanical (dry contact) relays are rated at 5 Amp for 28 VDC and 250 ~VAC **RESISTIVE** loads.

IMPORTANT: Appropriate diode (DC loads) or MOV (AC loads) snubber devices must be installed with inductive loads to prevent RFI noise spikes.

AC or DC power supplies to relays on the 299-0068-01 Relay PCB must be the same for each relay. Example: 24VDC should not be the power switched by one relay and 115VAC by others.

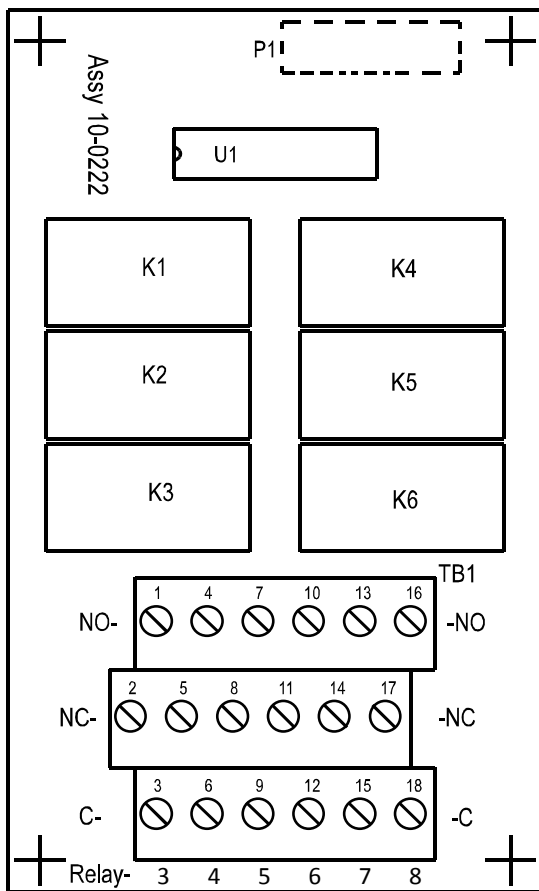

Note:
This board blocks access to the fuse and must be removed to replace a blown fuse.

Warning: For continued protection against fire replace only with same type and rating of fuse.

K1, K2, K3, K4, K5 & K6 are programmable as described in Section 10.6.1

TB1 terminals 1, 4, 7, 10, 13, & 16 are Normally Open Contacts for K1-K6

TB1 terminals 2, 5, 8, 11, 14 & 17 are Normally closed Contacts for K1-K6

TB1 terminals 3, 6, 9, 12, 15 & 18 are Common (pole) Contacts for K1-K6

Contacts are rated for 5 amp resistive loads. Arc suppressing snubber devices should be used for switching inductive loads.

Figure 11-3 299-0068-01 Relay Board

11.3 OPTIONAL 24VDC 50 WATT POWER SUPPLIES # 299-0044-01

Some applications require 24VDC power in excess of the 10 watts supplied by the PS1 power supply located on the motherboard (see Figure 11-2). SENSACAST CONTROLLER enclosures (see [Chapter 12](#)) may be equipped with an integral 299-0044-01 NEC Class 2 FIFTY WATT (see Figure 11-4).

“EXTENDED” series enclosures described in [Section 12](#) of this manual may include the 299-0044-01 DIN rail mounted 50 watt Power Supply module. Not available in NEMA 7 Explosion Proof wall mount enclosure.

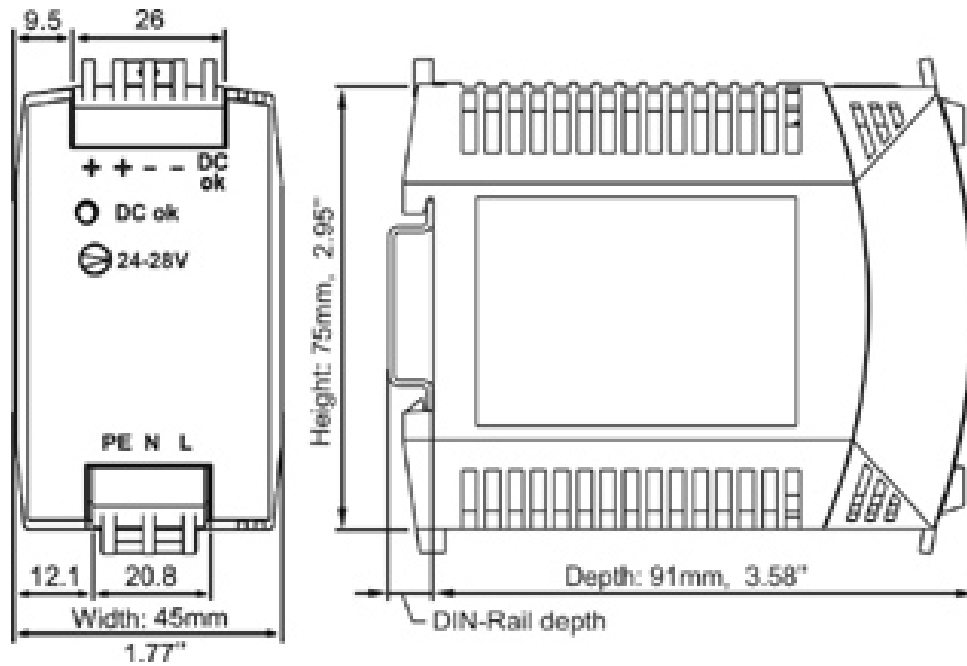

Figure 11-4 299-0044-01 50 Watt Power Supply

Chapter 12 – SENSCAST RECEIVER ENCLOSURE OPTIONS

12.1 SENSCAST CONTROLLER/PY NEMA 4X POLYESTER WALL MOUNT

The SENSCAST CONTROLLER/PY wall mount NEMA 4X enclosure is shown in Figure 12-1. Non-metallic enclosures are not grounded by metal conduit. For internal ground points to be grounded to earth, the TB5 – 3 GND terminal must have a proper earth ground connection (see Figure 11-2).

SENSCAST CONTROLLER/PY NEMA 4X non-metallic polyester wall mount. DIV 2 Groups A, B, C, D; Category II and pollution degree 3; NEMA 4X; IP66

CAUTION: NONMETALLIC ENCLOSURES DO NOT PROVIDE GROUNDING BETWEEN CONDUIT CONNECTIONS. USE GROUNDING TYPE BUSHINGS AND JUMPER WIRES. ALL FIELD WIRING MUST HAVE INSULATION SUITABLE FOR AT LEAST 250V.

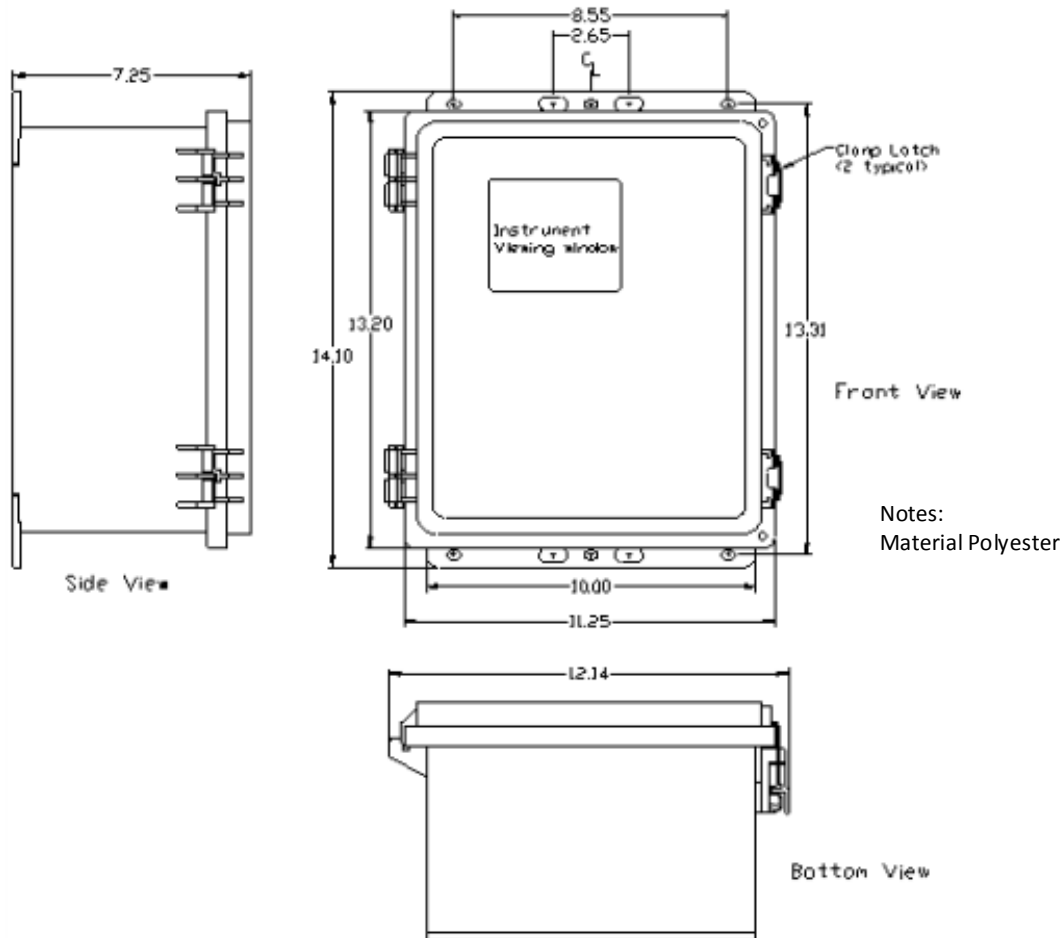

Figure 12-1 SENSCAST CONTROLLER/PY NEMA 4X Polyester Wall Mount Enclosure

12.2 SENSCAST CONTROLLER/PCS NEMA 4 PAINTED CARBON STEEL WALL MOUNT

The SENSCAST CONTROLLER/PCS shown in Figure 12-2 is a Painted Carbon Steel NEMA 4 wall mount enclosure designed for non-corrosive installations.

SENSCAST CONTROLLER/PCS NEMA 4 painted carbon steel wall mount. DIV 2 Groups A,B,C,D; Category II and pollution degree 3; NEMA 4; IP66

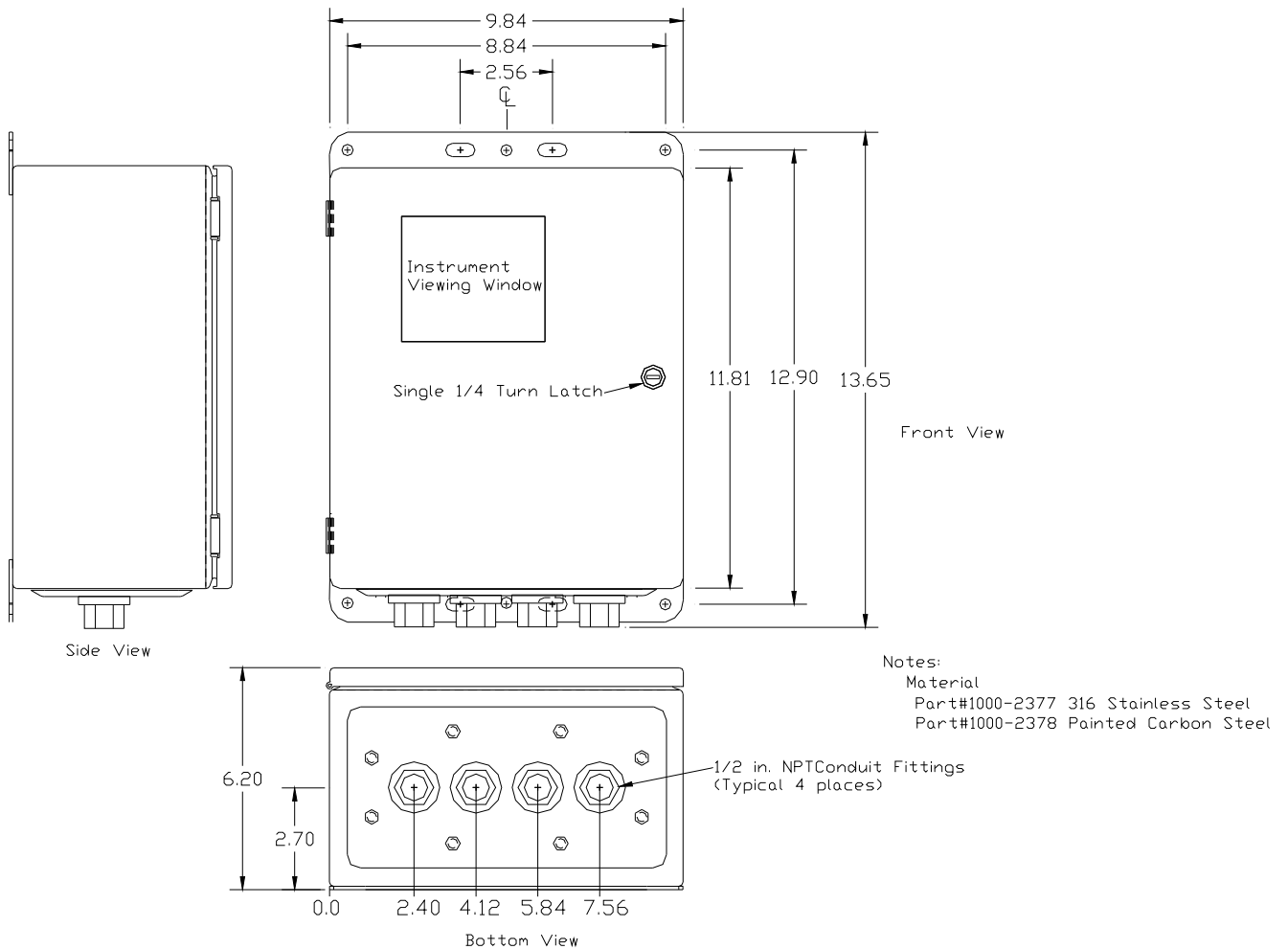

Figure 12-2 SENSCAST CONTROLLER/PCS NEMA 4 Painted Carbon Steel Wall Mount Enclosure

12.3 SENSCAST CONTROLLER/SS NEMA 4X STAINLESS STEEL WALL MOUNT

The SENSCAST CONTROLLER/SS shown in Figure 12-3 is a 316 Stainless Steel NEMA 4X wall mount enclosure designed for corrosive installations.

SENSCAST CONTROLLER/SS NEMA 4X stainless steel wall mount. DIV 2 Groups A,B,C,D; Category II and pollution degree 3; NEMA 4X; IP66

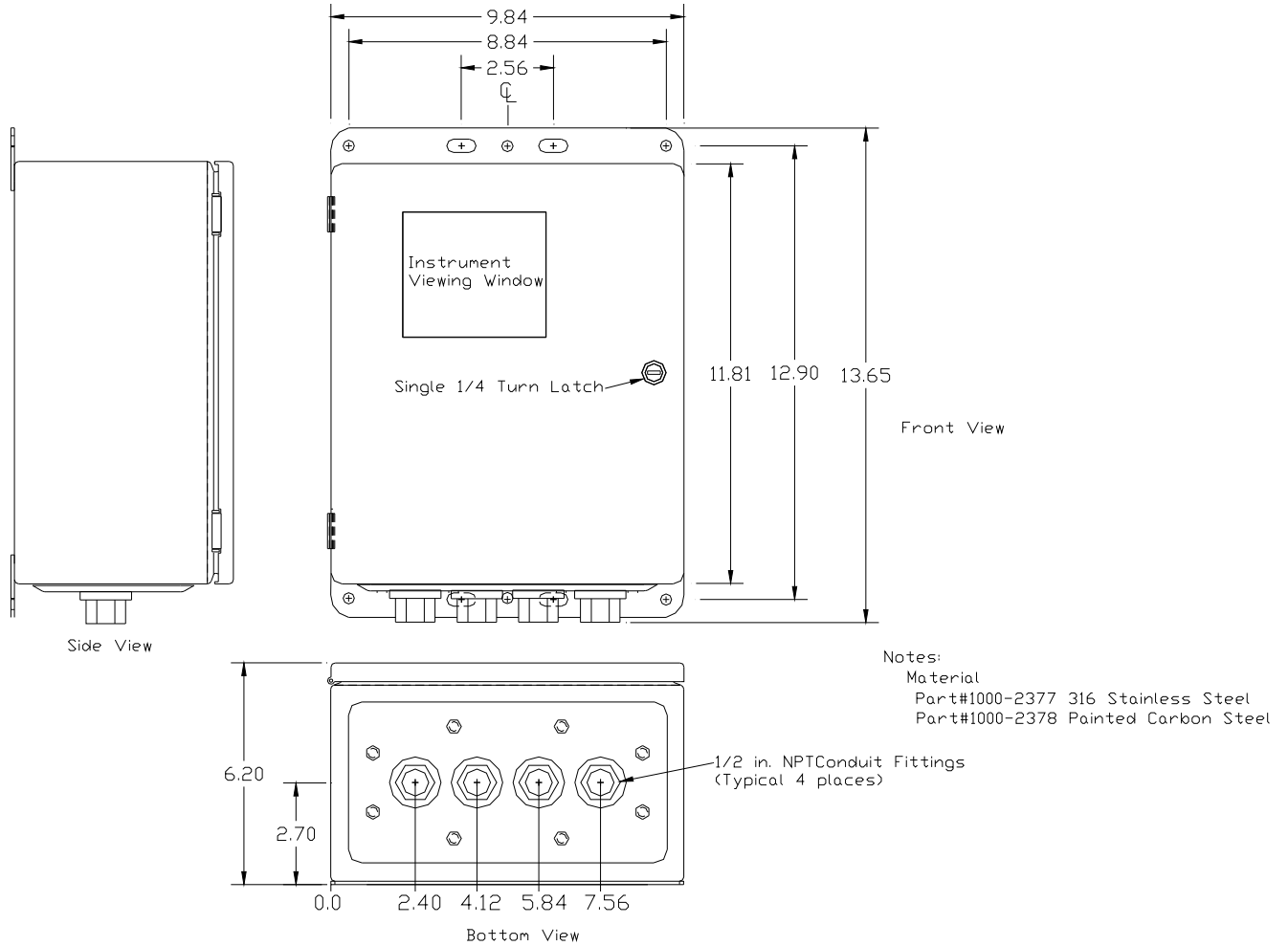

Figure 12-3 SENSICAST CONTROLLER/SS NEMA 4X Stainless Steel Wall Mount Enclosure

12.4 SENSICAST CONTROLLER/XP NEMA 7 EXPLOSION-PROOF WALL MOUNT

The SENSICAST CONTROLLER/XP shown in Figure 12-4 is aluminum NEMA 7 wall mount enclosure designed for mounting into potentially hazardous areas. (Note: 299-0044-01 DIN rail mounted 50 watt Power Supply module is not available for this enclosure.)

SENSICAST CONTROLLER/XP NEMA 7 wall mount for DIV 1 & 2 Groups B, C, D; includes 'O' Ring in door to satisfy NEMA 4 rating.

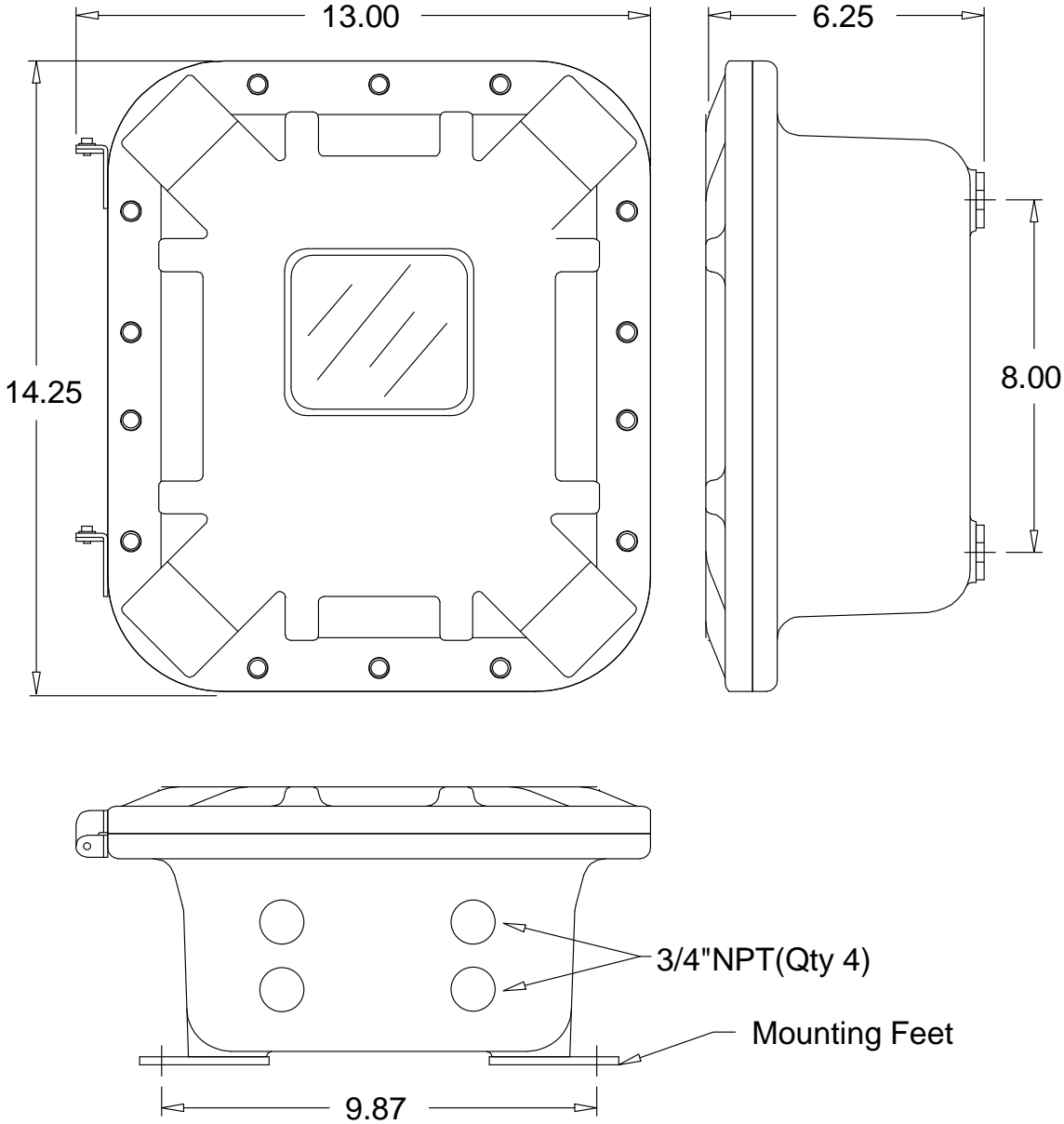

Figure 12-4 SENSICAST CONTROLLER/XP NEMA 7 Explosion Proof Wall Mount Enclosure

Chapter 13 – 299-0085-01 SENSICAST RECEIVER MULTI-FUNCTION OPTION

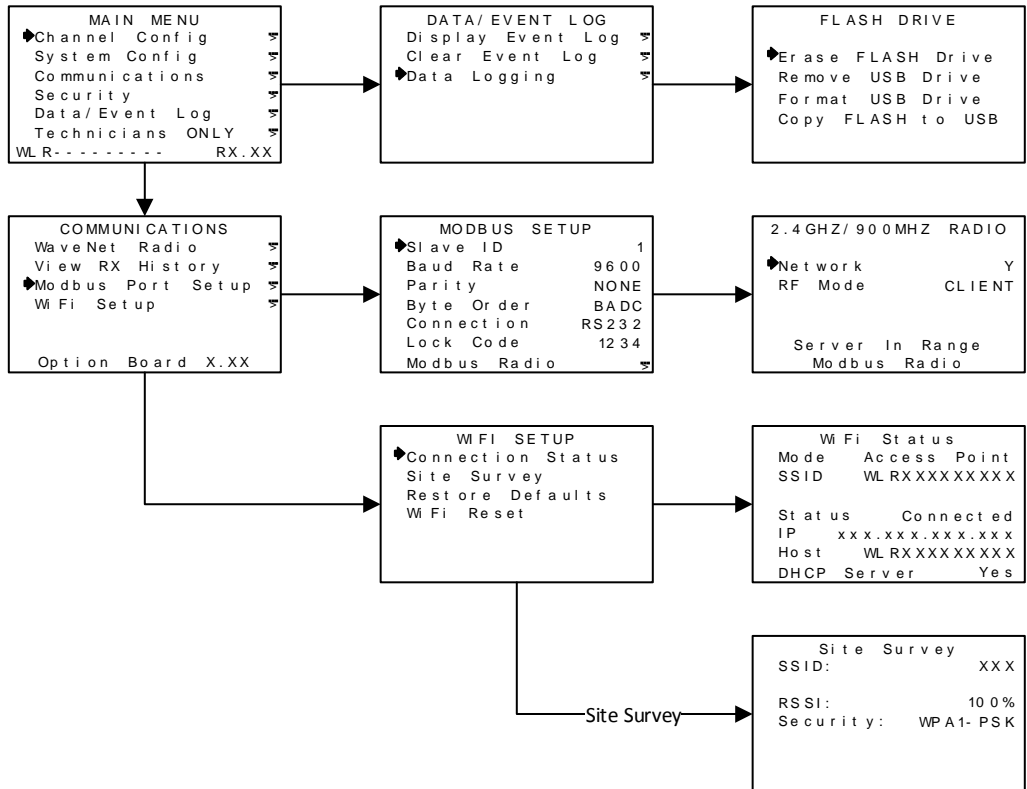

Figure 13-1 SENSICAST CONTROLLER Multi-Interface Option Board Menus

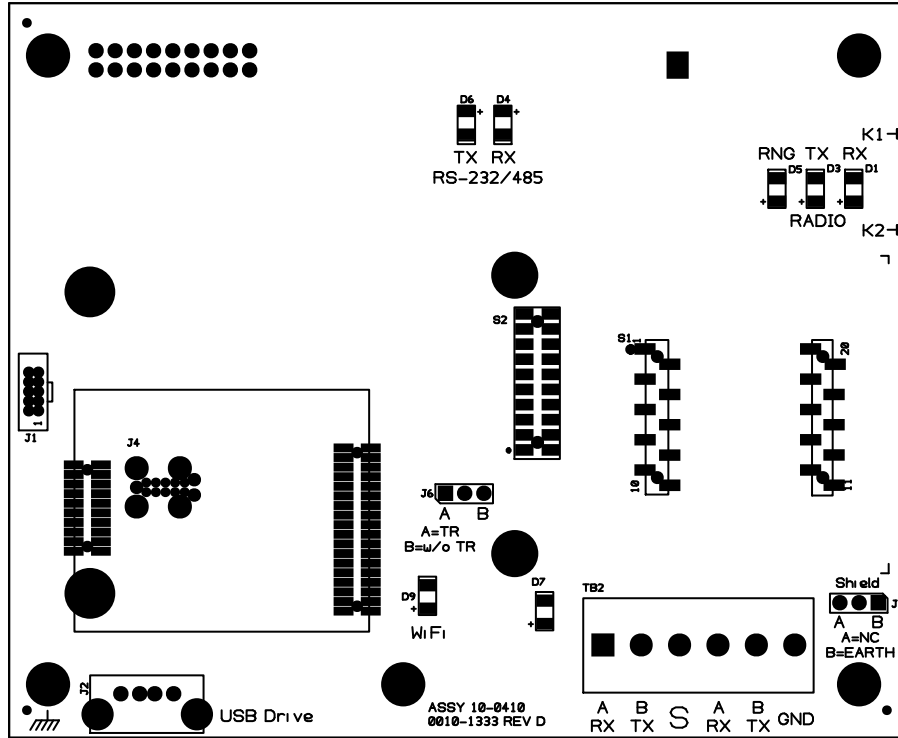

Figure 13-2 299-0085-01 SENSICAST Receiver Multifunction Option Board

13.1 MODBUS COMMUNICATIONS MENU

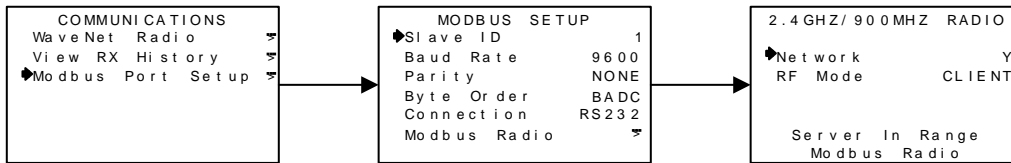

Figure 13-3 Modbus Communication Menu

The **MODBUS SETUP** menu allows setting of the system’s Modbus port. It may function as a wired **Modbus Slave** or wireless **Modbus Slave**.

Modbus Slave mode allows the communication port to be polled by any **Modbus Master** device using the Modbus RTU protocol. This setting is also utilized for Wireless Modbus Slave. This *slave* port may be used to transfer SENSICAST CONTROLLER data to a Modbus *master* device such as a PC, PLC, DCS or even other Sensidyne, LP Controllers such as the 16 Channel ST-71. The slave port is addressable, allowing many SENSICAST CONTROLLER controllers to be connected to a single RS-485 cable. A converter is available to make this port also compatible with Ethernet TCP/IP networks.

The entire Modbus database register list, is documented in [Section 13.1.1](#).

13.1.1 MODBUS REGISTER SUMMARY

The following table identifies the available Modbus RTU register locations.

<u>Register Name</u>	<u>Register</u>	<u>Number of Values</u>	<u>Number of Registers Per Value</u>	<u>Description</u>
<u>Input Registers</u>				
Read with function code 4				
MBREG_CH1_BINARY_OUTPUT	31001 - 31032			Unsigned integer 800-4000
MBREG_VERSION	32002			Integer (version multiplied by 100)
CONTROLLER_NAME	32005 - 32010			12 character ASCII name
<u>Relay States</u>				
RELAY_1_STATE	32100 -32107	8	1	0 = Not Energized, 1 = Energized
<u>Channel Data</u>				
BATTERY_VOLTAGE	33001 - 33064	32	2	32 floating points
FLOAT Value	33065 - 33128	32	2	32 floating points
VALUE_STRING	33129 - 33224	32	3	6 character ascii values
COMM_STATUS	33225 - 33256	32	1	0 = OK, 1 = Error, 2 = Connecting, 4 = Waiting for config
SENSOR_LIFE	33257 - 33288	32	1	0-100% Integer
COMM_TIMEOUT	33289 - 33320	32	1	
<u>Channel Flags</u>				
A1_STATUS	33449 - 33480	32	1	0 = No Alarm, 1 = Alarm
A2_STATUS	33481 - 33512	32	1	0 = No Alarm, 1 = Alarm
A3_STATUS	33513 - 33544	32	1	0 = No Alarm, 1 = Alarm
FAULT_STATUS	33545 - 33576	32	1	0 = No Fault, 1 = Fault
IN CAL	33577 - 33608	32	1	0 = Normal, 1 = In Cal
LOW_BATTERY	33609 - 33640	32	1	0 = Battery Ok, 1 = Low Battery
IN CAL_PURGE	33641 - 33672	32	1	0 = Normal, 1 = In Cal Purge
IN WARMUP	33673 - 33704	32	1	0 = Normal, 1 = In Warmup
EDIT_MODE	33705 - 33736	32	1	0 = Normal, 1 = Edit Mode Active
MISSING_SENSOR	33737 - 33768	32	1	0 = Normal, 1 = Missing Sensor
CAL_ERROR	33769 - 33800	32	1	0 = Normal, 1 = Cal Error

<u>Register Name</u>	<u>Register</u>	<u>Number of Values</u>	<u>Number of Registers Per Value</u>	<u>Description</u>
----------------------	-----------------	---------------------------------	--------------------------------------------------	--------------------

DATA_ERROR	33801 - 33832	32	1	0 = Normal, 1 = Data Error
CHANNEL_STATUS	33833 - 33864	32	1	0 = Normal, 1 = Any of the Following States : Low Battery, In Cal, In Cal Purge, Warmup, Edit Mode, Cal Error, Data Error

Channel Flag Bit Field Registers :

Bit0 = Channel 1, Bit31 = Channel 32

These should be read as 32bit unsigned integers. Byte order will affect these registers. 0 = State Inactive, 1 = State Active

PACKED_A1_STATUS	34000	1	2
PACKED_A2_STATUS	34002	1	2
PACKED_A3_STATUS	34004	1	2
PACKED_FAULT_STATUS	34006	1	2
PACKED_LOW_BATT	34008	1	2
PACKED_CAL	34010	1	2
PACKED_CAL_PURGE	34012	1	2
PACKED_WARMUP	34014	1	2
PACKED_EDIT_MODE	34016	1	2
PACKED_MISSING_SENSOR	34018	1	2
PACKED_CAL_ERROR	34020	1	2
PACKED_DATA_ERROR	34022	1	2
PACKED_CHANNEL_STATUS	34024	1	2
PACKED_CHANNEL_ENABLE	34026	1	2
PACKED_COMM_ERROR	34028	1	2

Holding Registers

Read with function code 3

ALARM_RESET	40001			Write 1 to Reset. Function code 6
DATE_YEAR	40020	1	1	Unsigned integer
DATE_MONTH	40021	1	1	Unsigned integer
DATE_DAY	40022	1	1	Unsigned integer
TIME_HOUR	40023	1	1	Unsigned integer
TIME_MINUTE	40024	1	1	Unsigned integer
TIME_SECOND	40025	1	1	Unsigned integer
RELAY_REFRESH_TIME	40026	1	1	Unsigned integer (Minutes)

<u>Register Name</u>	<u>Register</u>	<u>Number of Values</u>	<u>Number of Registers Per Value</u>	<u>Description</u>
-----------------------------	------------------------	--------------------------------	---------------------------------------------	---------------------------

CHANNEL_COUNT	40027	1	1	Unsigned integer (1 - 32)
PIEZO_REFRESH	40028	1	1	Unsigned integer (Minutes)
PIEZO_ENABLE	40029	1	1	0 = Not Enabled, 1 = Enabled

Serial Port Registers

COM1_MODE	40034	1	1	TBD
COM1_BAUDRATE	40035	1	1	0 = 9600, 1 = 19200, 2 = 38400, 3 = 57600, 4 = 115200
COM1_PARITY	40036	1	1	0 = None, 1 = Even, 2 = Odd
COM1_SLAVE_ID	40037	1	1	Unsigned integer
COM1_BYTE_ORDER	40038	1	1	0 = ABCD, 1 = CDAB, 2 = BADC, 3 = DCBA
COM1_PORT_TYPE	40039	1	1	0 = RS-485, 1 = RS-232, 3 = Disabled

Radio Port Registers

COM2_MODE	40040	1	1	TBD
COM2_BYTE_ORDER	40041	1	1	0 = ABCD, 1 = CDAB, 2 = BADC, 3 = DCBA
SERIAL_RADIO_NETWORK	40042	1	1	1 = Network A... 26 = Network Z
SERIAL_RADIO_TX_POWER	40043	1	1	0 = 10mW, 1 = 200mW, 2 = 400mW, 3 = 1W
SERIAL_RADIO_MODE	40044	1	1	1 = Server, 2 = Client
LOCK_CODE	40046	1	1	Unsigned integer, 4 digits
PIEZO_RLY1	40050	1	1	0 = Disabled, 1 = Enabled
PIEZO_RLY2	40051	1	1	0 = Disabled, 1 = Enabled
PIEZO_RLY3	40052	1	1	0 = Disabled, 1 = Enabled
PIEZO_RLY4	40053	1	1	0 = Disabled, 1 = Enabled
PIEZO_RLY5	40054	1	1	0 = Disabled, 1 = Enabled
PIEZO_RLY6	40055	1	1	0 = Disabled, 1 = Enabled
PIEZO_RLY7	40056	1	1	0 = Disabled, 1 = Enabled
PIEZO_RLY8	40057	1	1	0 = Disabled, 1 = Enabled

<u>Register Name</u>	<u>Register</u>	<u>Number of Values</u>	<u>Number of Registers Per Value</u>	<u>Description</u>
-----------------------------	------------------------	--------------------------------	---------------------------------------------	---------------------------

WiFi/Network

Configuration

WIFI_IP_ADDRESS	40100 - 40101	1	2	4byte IP Fields
WIFI_GATEWAY	40102 - 40103	1	2	4byte IP Fields
WIFI_NETMASK	40104 - 40105	1	2	4byte IP Fields
IP_ADDRESS	40106 - 40107	1	2	4byte IP Fields
DHCP_START	40108 - 40109	1	2	4byte IP Fields
DHCP_END	40110 - 40111	1	2	4byte IP Fields
DHCP_SERVER	40120	1	1	0 = Not Enabled, 1 = Enabled
DHCP_CLIENT	40121	1	1	0 = Static IP, 1 = DHCP Client
WIFI_BAND	40122	1	1	0 = 802.11BG, 2 = 802.11B, 3 = 802.11G
WIFI_MODE	40123	1	1	0 = Access Point, 3 = Client
WIFI_CHANNEL	40124	1	1	0-13
WIFI_TX_POWER	40125	1	1	0-16dBm
WIFI_DATA_RATE	40126	1	1	0 = 1Mbps, 1 = 2Mbps, 2 = 5Mbps, 3 = 11Mbps, 4 = 24Mbps, 5 = 36Mbps, 6 = 48Mbps, 7 = 54Mbps
WIFI_BROADCAST_SSID	40127	1	1	0 = Not Enabled, 1 = Enabled
WIFI_AUTH_MODE	40128	1	1	0 = Open/Shared, 1 = Open, 3 = Shared, 5 = WPA/PSK, 7 = WPA2/PSK
WIFI_ENCRYPT	40129	1	1	0 = None, 1 = WEP, 2 = TKIP, 3 = AES
WIFI_KEY_LENGTH	40131	1	1	0 = None, 1 = 64bit, 2 = 128bit
WIFI_KEY_FORMAT_WEP	40132	1	1	0 = ASCII, 1 = Hex
WIFI_KEY_FORMAT_WPA	40133	1	1	0 = Passphrase, 1 = Hex
WIFI_DHCP_CLIENT	40134	1	1	0 = Disabled, 1 = Enabled
WIFI_ENABLED	40135	1	1	0 = Disabled, 1 = Enabled
SSID	40200 - 40215	1	16	32 character ASCII
HOST_NAME	40224 - 40232	1	8	16 character ASCII

Channel Configuration

CH1_TAG	40401 - 40656	32	8	16 character ASCII
CH1_UNITS	40657 - 40816	32	5	10 character ASCII
CH1_ENABLE	41000 - 41031	32	1	0 = Disabled, 1 = Enabled
CH1_RTU_ID	41032 - 41063	32	1	Integer
CH1_DISP_DP	41064 - 41095	32	1	Integer

<u>Register Name</u>	<u>Register</u>	<u>Number of Values</u>	<u>Number of Registers Per Value</u>	<u>Description</u>
-----------------------------	------------------------	--------------------------------	---------------------------------------------	---------------------------

CH1_ZERO_VALUE	41096 - 41159	32	2	32bit Floating point
CH1_SPAN_VALUE	41160 - 41223	32	2	32bit Floating point
CH1_A1_SETPOINT	41224 - 41287	32	2	32bit Floating point
CH1_A2_SETPOINT	41288 - 41351	32	2	32bit Floating point
CH1_A3_SETPOINT	41352 - 41415	32	2	32bit Floating point
CH1_FAULT_LEVEL	41416 - 41479	32	2	32bit Floating point

Relay Configuration

RLY1_TRIP	42000 - 42007	8	1	0 = Low Trip, 1 = High Trip
RLY1_LATCH	42008 - 42015	8	1	0 = Not Latching, 1 = Latching
RLY1_FAILSAFE	42016 - 42023	8	1	0 = Not Failsafe, 1 = Failsafe
RLY1_ACKNOWLEDGE	42024 - 42031	8	1	0 = Not Enabled, 1 = Enabled

Relay enable flags for each channel

RLY1_CH1	42200 - 42207	8	1	0 = Not Enabled, 1 = Enabled
RLY1_CH2	42208 - 42215	8	1	0 = Not Enabled, 1 = Enabled
RLY1_CH3	42216 - 42223	8	1	0 = Not Enabled, 1 = Enabled
RLY1_CH4	42224 - 42231	8	1	0 = Not Enabled, 1 = Enabled
RLY1_CH5	42232 - 42239	8	1	0 = Not Enabled, 1 = Enabled
RLY1_CH6	42240 - 42247	8	1	0 = Not Enabled, 1 = Enabled
RLY1_CH7	42248 - 42255	8	1	0 = Not Enabled, 1 = Enabled
RLY1_CH8	42256 - 42263	8	1	0 = Not Enabled, 1 = Enabled
RLY1_CH9	42264 - 42271	8	1	0 = Not Enabled, 1 = Enabled
RLY1_CH10	42272 - 42279	8	1	0 = Not Enabled, 1 = Enabled
RLY1_CH11	42280 - 42287	8	1	0 = Not Enabled, 1 = Enabled
RLY1_CH12	42288 - 42295	8	1	0 = Not Enabled, 1 = Enabled
RLY1_CH13	42296 - 42303	8	1	0 = Not Enabled, 1 = Enabled
RLY1_CH14	42304 - 42311	8	1	0 = Not Enabled, 1 = Enabled
RLY1_CH15	42312 - 42319	8	1	0 = Not Enabled, 1 = Enabled
RLY1_CH16	42320 - 42327	8	1	0 = Not Enabled, 1 = Enabled
RLY1_CH17	42328 - 42335	8	1	0 = Not Enabled, 1 = Enabled
RLY1_CH18	42336 - 42343	8	1	0 = Not Enabled, 1 = Enabled
RLY1_CH19	42344 - 42351	8	1	0 = Not Enabled, 1 = Enabled
RLY1_CH20	42352 - 42359	8	1	0 = Not Enabled, 1 = Enabled
RLY1_CH21	42360 - 42367	8	1	0 = Not Enabled, 1 = Enabled
RLY1_CH22	42368 - 42375	8	1	0 = Not Enabled, 1 = Enabled
RLY1_CH23	42376 - 42383	8	1	0 = Not Enabled, 1 = Enabled
RLY1_CH24	42384 - 42391	8	1	0 = Not Enabled, 1 = Enabled

<u>Register Name</u>	<u>Register</u>	<u>Number of Values</u>	<u>Number of Registers Per Value</u>	<u>Description</u>
RLY1_CH25	42392 - 42399	8	1	0 = Not Enabled, 1 = Enabled

RLY1_CH26	42400 - 42407	8	1	0 = Not Enabled, 1 = Enabled
RLY1_CH27	42408 - 42415	8	1	0 = Not Enabled, 1 = Enabled
RLY1_CH28	42416 - 42423	8	1	0 = Not Enabled, 1 = Enabled
RLY1_CH29	42424 - 42431	8	1	0 = Not Enabled, 1 = Enabled
RLY1_CH30	42432 - 42439	8	1	0 = Not Enabled, 1 = Enabled
RLY1_CH31	42440 - 42447	8	1	0 = Not Enabled, 1 = Enabled
RLY1_CH32	42448 - 42455	8	1	0 = Not Enabled, 1 = Enabled

13.2 WIRELESS MODBUS OPTION

13.2.1 WIRELESS MODBUS SLAVE MODE

Wireless MODBUS allows one or many SENSICAST CONTROLLERS to function as wireless modbus *slaves* by selecting **Wireless MODBUS** in the **COMM SETUP** menu (Figure 5.3). These wireless networks require a modbus *master* such as a DCS, HMI, or another Sensidyne, LP Controller equipped with our compatible radio modem. As in all Sensidyne, LP wireless networks, one transceiver must be designated as Server and all others as Clients. No special configuration is required by the *master* or *slave* since this is a standard modbus network. However, radios must have the same **Hop Channel** and **System ID** settings to communicate.

The entire SENSICAST CONTROLLER modbus database, including registers and supported Function Codes, is documented in [Section 13.1](#).

13.3 WIFI COMMUNICATIONS OPTION

The Wi-Fi Communications option provides a webpage interface for viewing and editing the SensCast System Information including all alarms and set points to the particular SensCast Receiver being monitored.

Any web-enabled device with Wi-Fi capabilities may be used to access the SENSICAST CONTROLLER's webpage. Simply search for the SSID of the SENSICAST CONTROLLER to connect to, and enter the SENSICAST CONTROLLER's IP address in your device's address bar.

13.3.1 SENSICAST RECEIVER WIFI MENUS

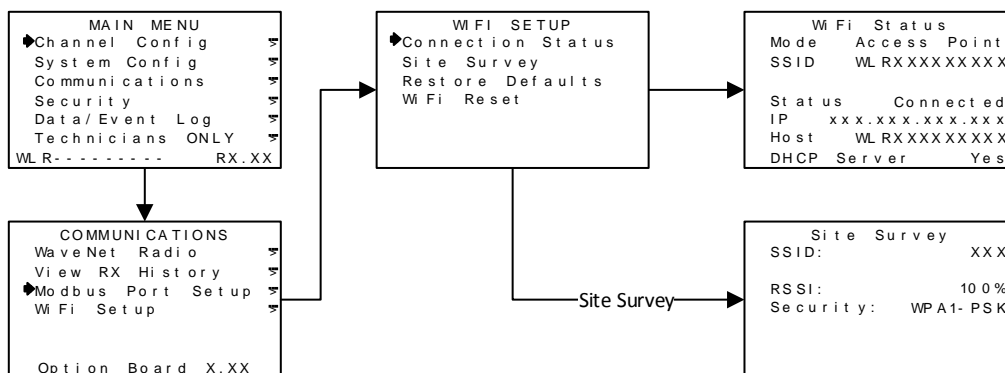

Figure 13-4 SensCast Receiver Wi-Fi Menu Tree

When accessing the SENSCAST CONTROLLER via Wi-Fi, there are two modes of operation: 1. SENSCAST CONTROLLER as an Access Point 2. SENSCAST CONTROLLER as a Client. By default, the SENSCAST CONTROLLER will be set to Access Point. To change the SENSCAST CONTROLLER to client mode refer to [Section 13.3.2](#).

Connection Status provides all of the Wi-Fi settings needed to access the SENSCAST CONTROLLER's webpage. **Mode** displays whether the SENSCAST CONTROLLER is set to Access Point or Client. **SSID** is the identification number of the Wi-Fi network for the SENSCAST CONTROLLER. **Status** shows the current status of the Wi-Fi module. **IP** shows the IP Address for the webpage, and is entered in the browser's address bar to view the SENSCAST CONTROLLER on a web-enabled device. **Host** shows the host network for the SENSCAST CONTROLLER. When acting as an Access Point this will match the SSID, and when acting as a client it will display the SSID of the Host network. **DHCP Server** is a protocol which, when enabled, allows the host server to assign the IP address to the device.

Note: All fields in the **Connection Status** menu can only be viewed on the SENSCAST CONTROLLER, and can be edited from the webpage ([Section 13.3.2](#))

Site Survey surveys the area for any available host networks, and is useful in determining which network to use as the host network when connecting multiple SENSCAST CONTROLLER's to a single Access Point. This will display the SSID of available networks in the area, the RSSI (signal strength) and the type of security protocol. To cycle through the available networks select **EDIT**.

Restore Defaults restores the Wi-Fi module to the default settings.

Wi-Fi Reset resets the Wi-Fi module.

13.3.2 WEBPAGE MENUS

The main page for the SensCast Receiver's Webpage is the **Status Page**. On this page, every active channel (1-32 channels) is displayed with their **Channel Number**, **Measurement Name** and **Measurement Reading**. When no alarm condition is present, the display box for that channel is Green (Figure 13-4). When a channel is in Alarm 1 its display box is yellow, and red when in Alarm 2 (Figure 13-5).

The relay display boxes indicate whether or not the relay is energized. When the relay is not energized the box is white, when the relay is energized the box is red.

Note: Any relay in Failsafe mode will be shown in red during normal operations, and white when the alarm condition is present.

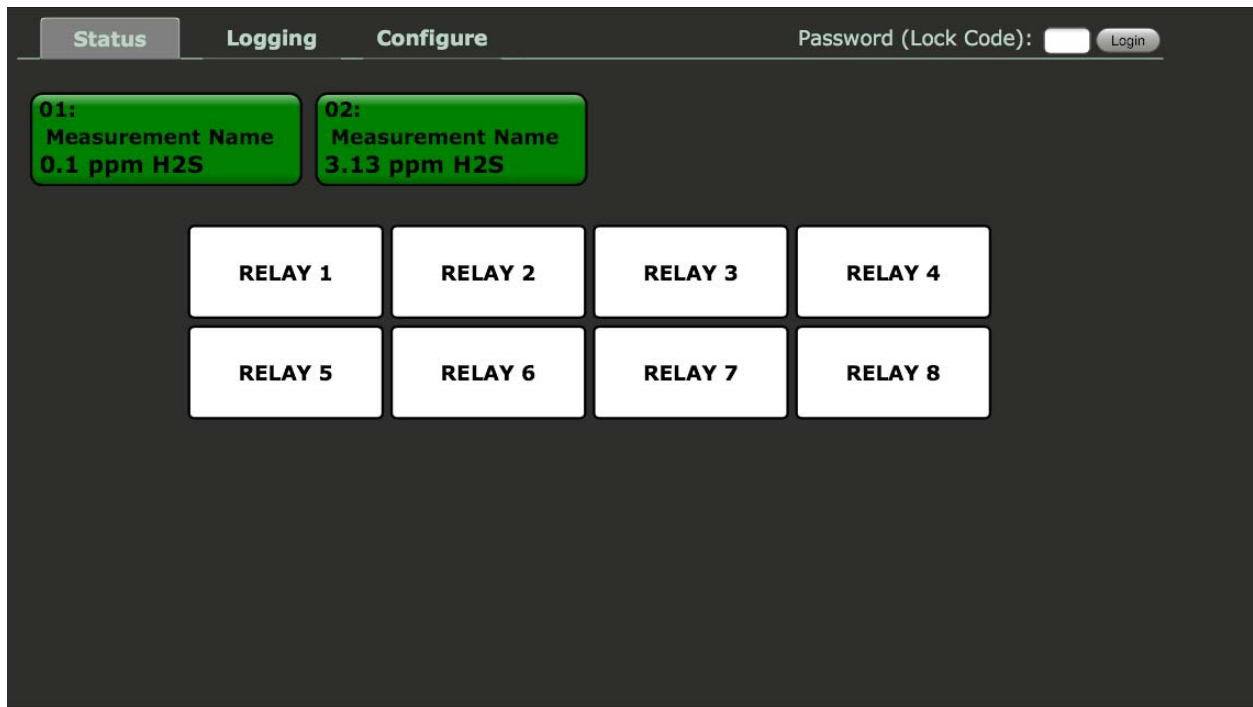

Figure 13-5 Webpage Status Screen (No Alarms)

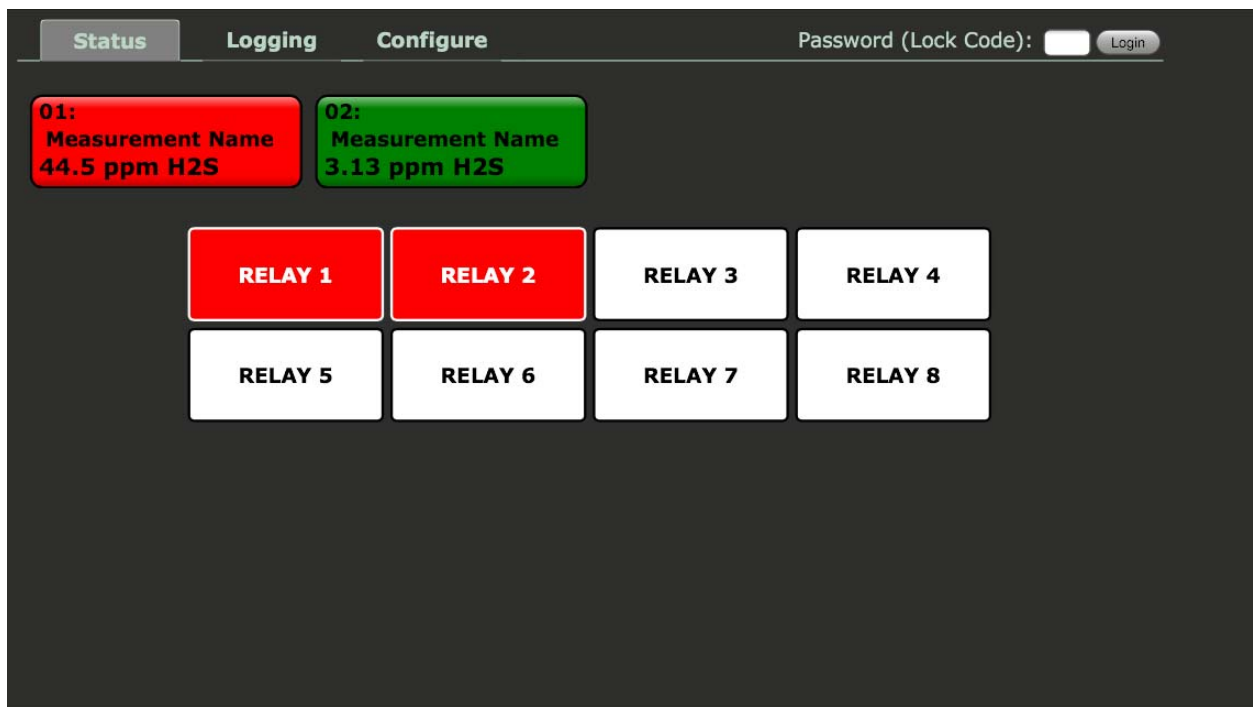

Figure 13-6 Webpage Status Screen (With Alarms)

The following Configuration Menus are reached by selecting the **Configure** tab at the top of the window and selecting the desired menu.

The **Relay Config Menu** (Figure 13-6) allows the user to change or view the settings for all 8 configurable relays of the SENSICAST CONTROLLER. The **Relay** to configure is selected by using the drop down menu in the upper left hand corner. The user can then select what the relay will trip on, select **Latching**, **Failsafe** and/or **Acknowledge** options. To provide zoning features the Relay can be mapped to the desired channels using the **Selected Channels** matrix on the right side of the screen. To update the relay configuration select the **Save** button at the bottom of the screen.

For detailed descriptions of the various relay settings, refer to [Section 10.6.1](#).

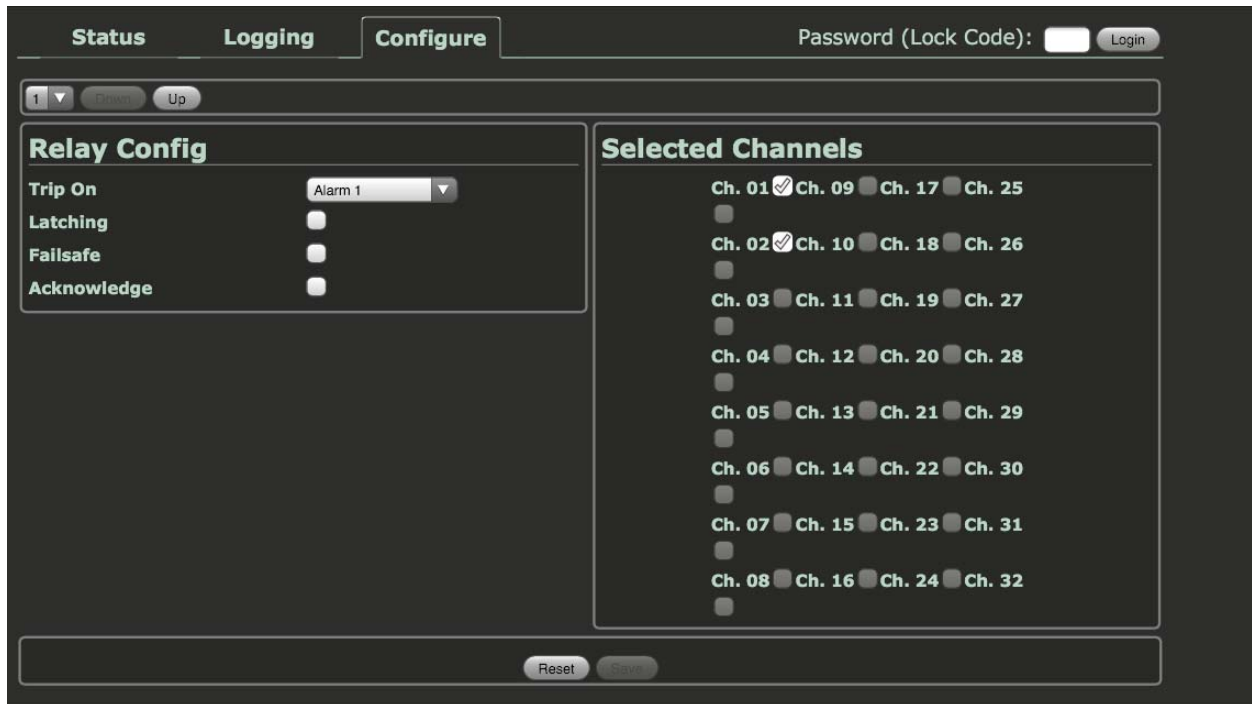

Figure 13-7 Relay Config Menu

The **Channel Config Menu** allows the user to activate or deactivate a channel using the **Channel Active** check box and/or change the channel's **RTU ID** number. The channel to be edited is selected using the drop down box in the upper left corner of the screen. The **Channel Info** is then displayed in the Channel Info window on the right side of the screen. To save any changes select the **Save** button at the bottom of the screen.

For a detailed description of the Channel Config Menu options refer to [Section 10.5](#).

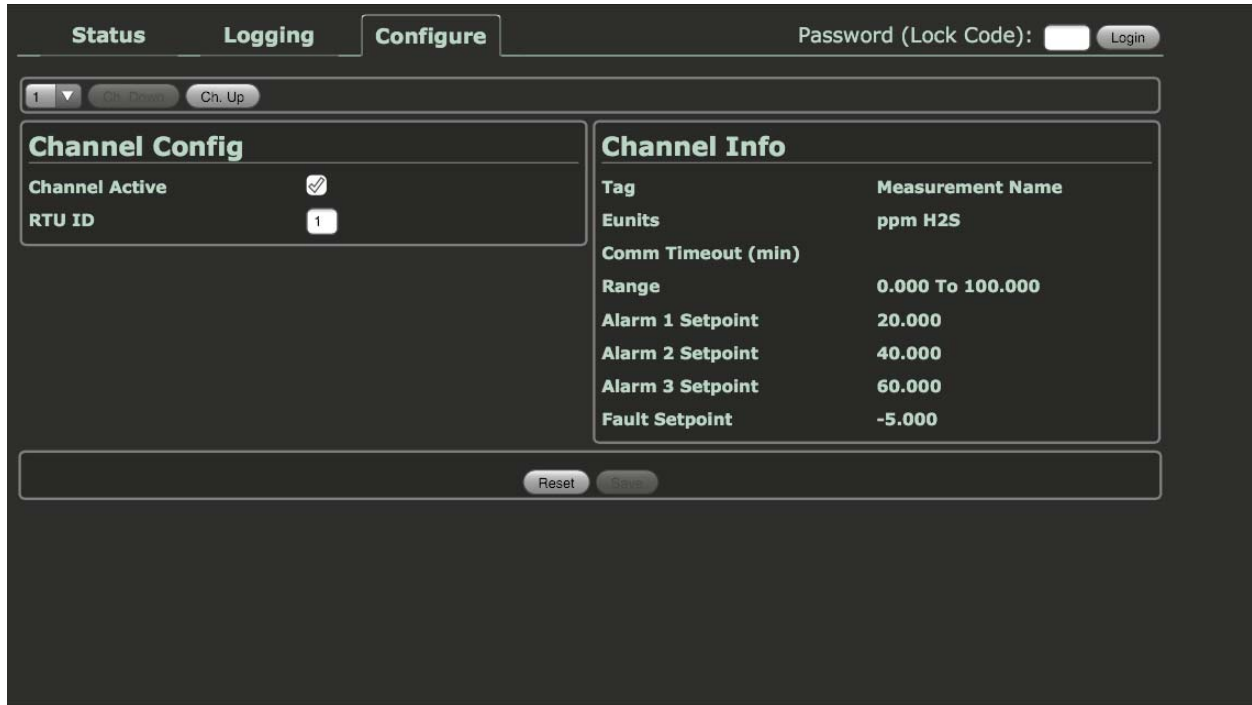

Figure 13-8 Channel Config Menu

The **System Config Menu** (Figure 13-8) allows the user to set the number of active channels, relay refresh and piezo refresh timers and enable/disable the local piezo. The user may also set the time and date, and complete the piezo function table as in [Section 10.6.2](#). For a more detailed description of the **System Config Menu** options refer to [Section 10.6](#).

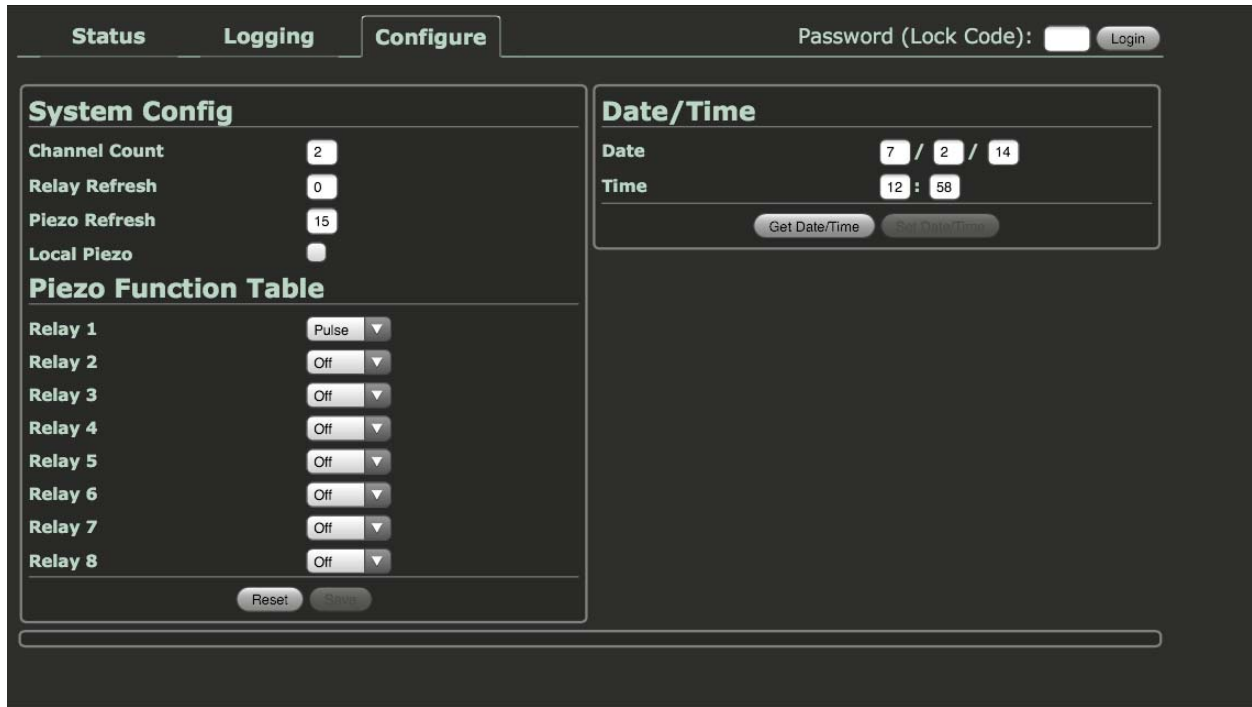

Figure 13-9 System Config Menu

WARNING: Changing Wi-Fi configuration will reset the network and this page will become temporarily inaccessible. If the new settings are invalid, the network will not restart. In this case, restore defaults from the Wi-Fi settings menu on the SENSICAST CONTROLLER controller.

The Wi-Fi Config Menu (Figure 13-9) allows the user to configure the Wi-Fi network for the SENSICAST CONTROLLER. These settings may only be changed from the webpage. A SENSICAST CONTROLLER may be configured as an Access Point or a Client on a Wi-Fi network. To view available Access Points a site survey must first be conducted from the SENSICAST CONTROLLER. Once the SSID of the desired access point is known the Wi-Fi mode may be switched to client and the settings for the Access Point network entered in the appropriate fields. An advantage to configuring multiple SENSICAST CONTROLLERs to a single access point is that they can each be read using their unique IP address, however, only one Wi-Fi connection is necessary.



Figure 13-9 Wi-Fi Config Menu

The Serial Config Menu (Figure 13-9) allows the user to update the serial configuration settings and set the Modbus radio settings for the SENSICAST CONTROLLER. For details on the Modbus settings refer to [Section 13.1](#).

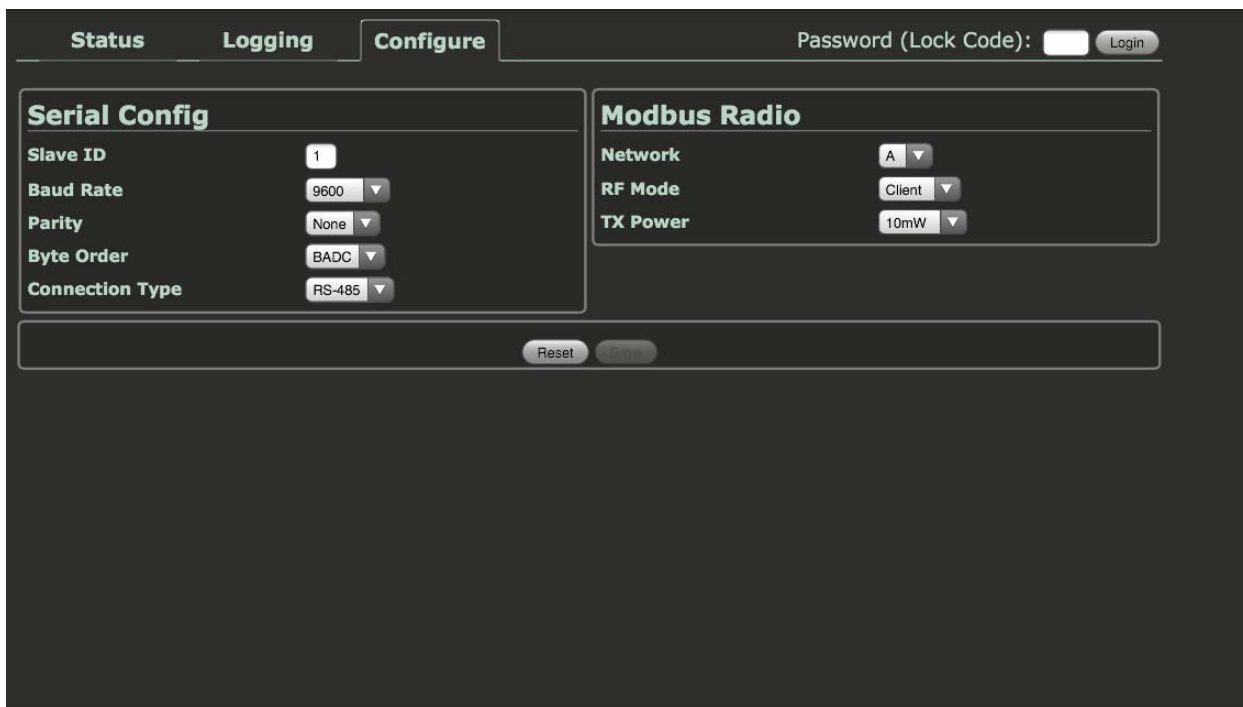

Figure 13-9 Serial Config Menu

13.4 DATA LOGGING AND USB OPTION

The 299-0085-01 Multi-Function Board (MFB) comes with onboard Flash memory for logging detailed data for the SensCast Receiver including channel readouts and events. The data log files can be copied from the Flash to a USB device and read as CSV files on a computer, or they can be read on a device via the webpage if the MFB is equipped with the Wi-Fi option.

13.4.1 DATA LOGGING FILE STRUCTURE

The Data Logging File structure is shown in Figure 13-9. Select the file for the SENSCAST CONTROLLER to be viewed. The files are then stored by year, month and finally as individual CSV files for each day and the alarm log. Opening the CSV file shows the list of readings for each channel for that day up to the point where the data log was uploaded to the memory device.

The data logger logs channel reading every 30 seconds when in alarm and every five minutes when not in alarm. The CSV files have a column for the time of the log and each active channel at that time and its reading. Each month has an evt.csv file which displays any events for that month. For a detailed description of events see [Section 10.9.1](#).

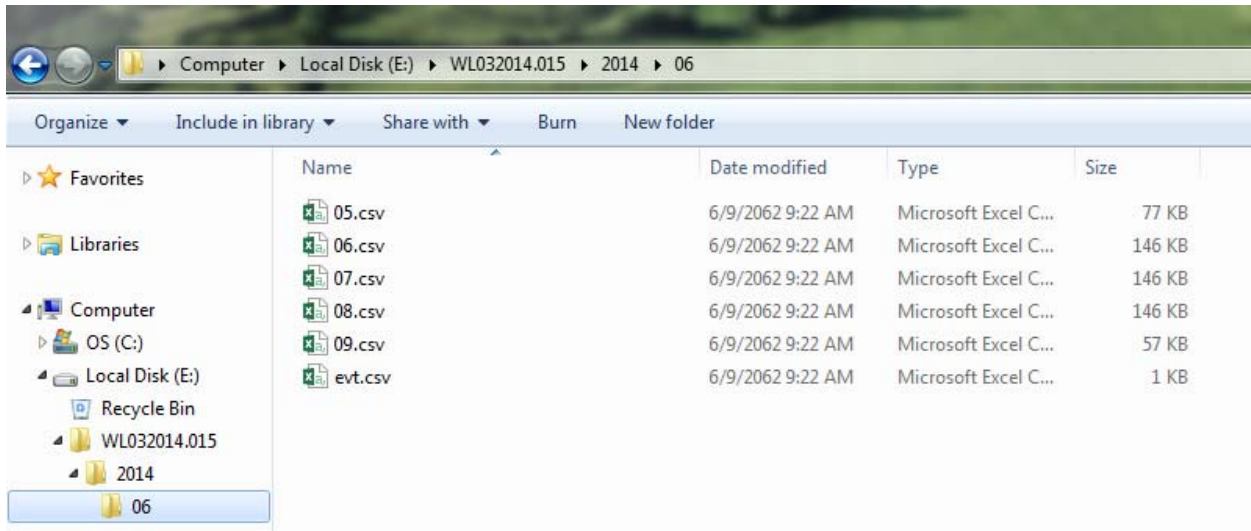

Figure 13-10 Data Logging File Structure

13.4.2 SENSCAST RECEIVER DATA LOGGING MENUS

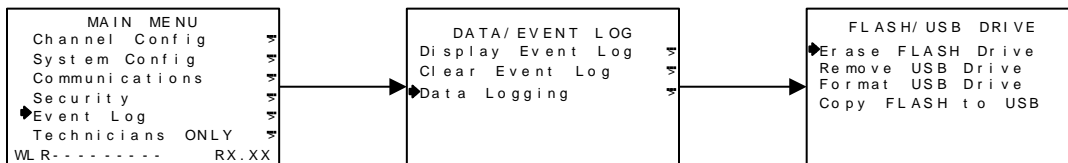

Figure 13-11 SENSCAST CONTROLLER Data Logging Menu Tree

13.4.3 WEBPAGE DATA LOGGING MENUS

To access the data logs via the webpage (Figure 13-11) select the Logging tab at the top of the screen. To navigate to the desired day or event log select the desired SENSCAST CONTROLLER, year, month and then either the event or day CSV file. To move back select up, and to update the files select refresh.

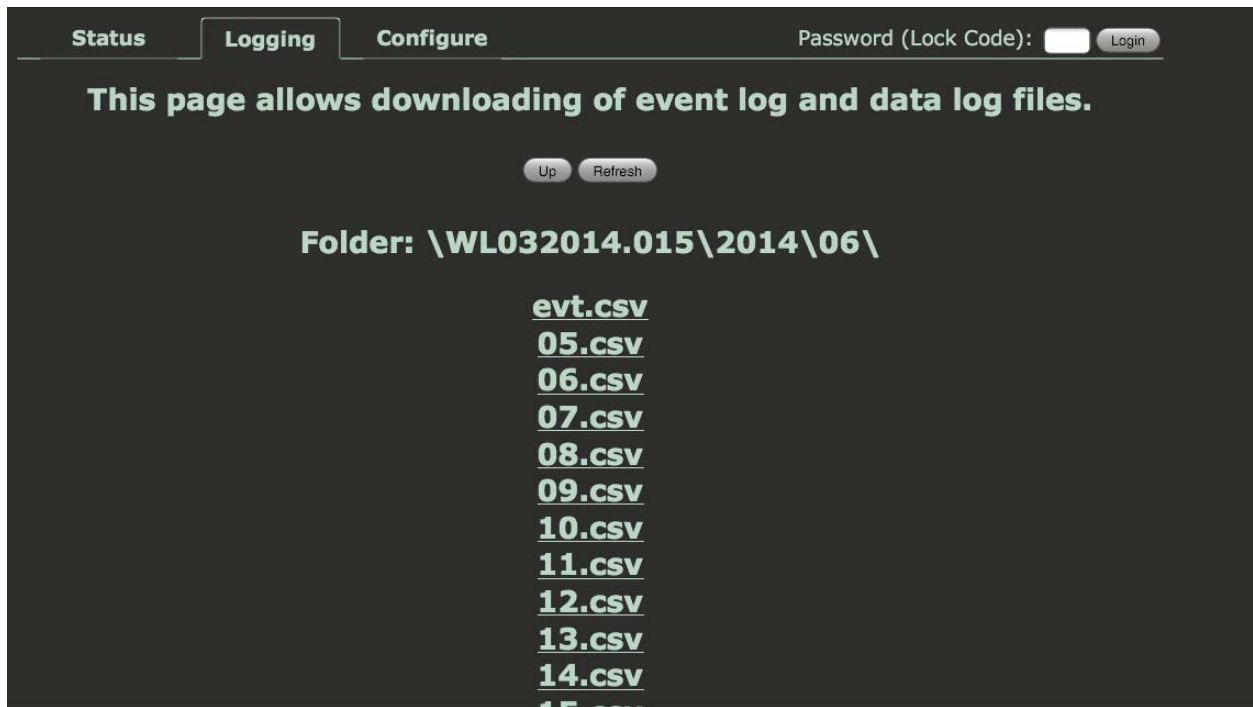

Figure 13-12 Webpage Data Logging Menu

SENSCAST RELAYER

Chapter 14 – SENSICAST RELAYER DESCRIPTION

14.1 SENSICAST RELAYER DESCRIPTION

The Sensidyne, LP SensCast Relayer (SENSICAST RELAYER) is designed to control alarm event relay switching for up to 32 SensCast Monitors. The SENSICAST RELAYER receives Fail, Alarm 1, Alarm 2 and Alarm 3 signals from each SENSICAST TRANSMITTER, maps them to its four programmable relays, while adding features such as Failsafe, Alarm Acknowledge and Refresh. Four standard 5-amp alarm relays may be programmed to activate based upon various alarm combinations. These four programmable relays may then be mapped to a single dedicated horn drive which may be set to off, pulse or steady for each of the relays.

A backlit graphic LCD and front LEDs clearly indicate the alarm status of monitored channels (Figure 14-1). When there are no channels with alarm conditions the SENSICAST CONTROLLER displays **ALARMS STATUS CLEAR** as the Main Screen. However, when there are channels with alarms the **ALARMS STATUS CLEAR** screen is replaced by the **Channel Alarm Status** screen which displays any active channel in alarm, and followed by an alternating line which shows the channel's Measurement Name and the current alarm. To view the alarming details enter the channel's Channel Setup Menu discussed in [Section 14.2.2](#).

On the right side of the screen is found the range indicator. One of four indicators will be displayed vertically. When the SENSICAST RELAYER has been out of range of the server for at least 30 seconds the Previously Out of Range icon will be displayed:

1. When SENSICAST RELAYER is a server:

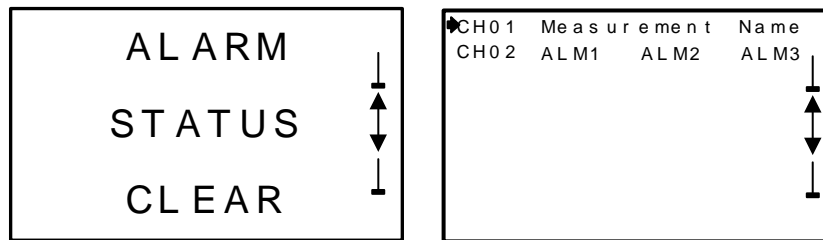
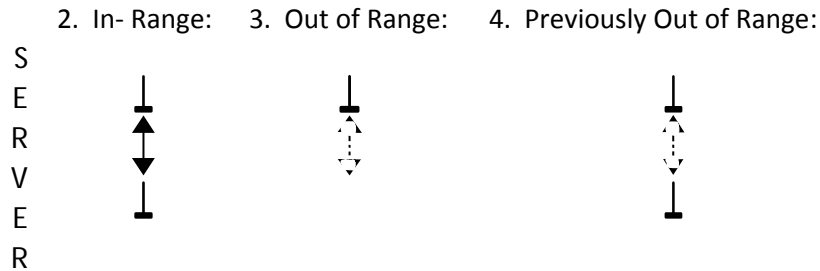

Figure 14-1 SENSICAST Relayer Main Screen

14.2 SENSICAST RELAYER MENUS

Below, in Figure 14.2, is the complete menu tree for the SensCast Relayer. To navigate the menus use the magnetic keypad discussed in [Section 5.1](#).

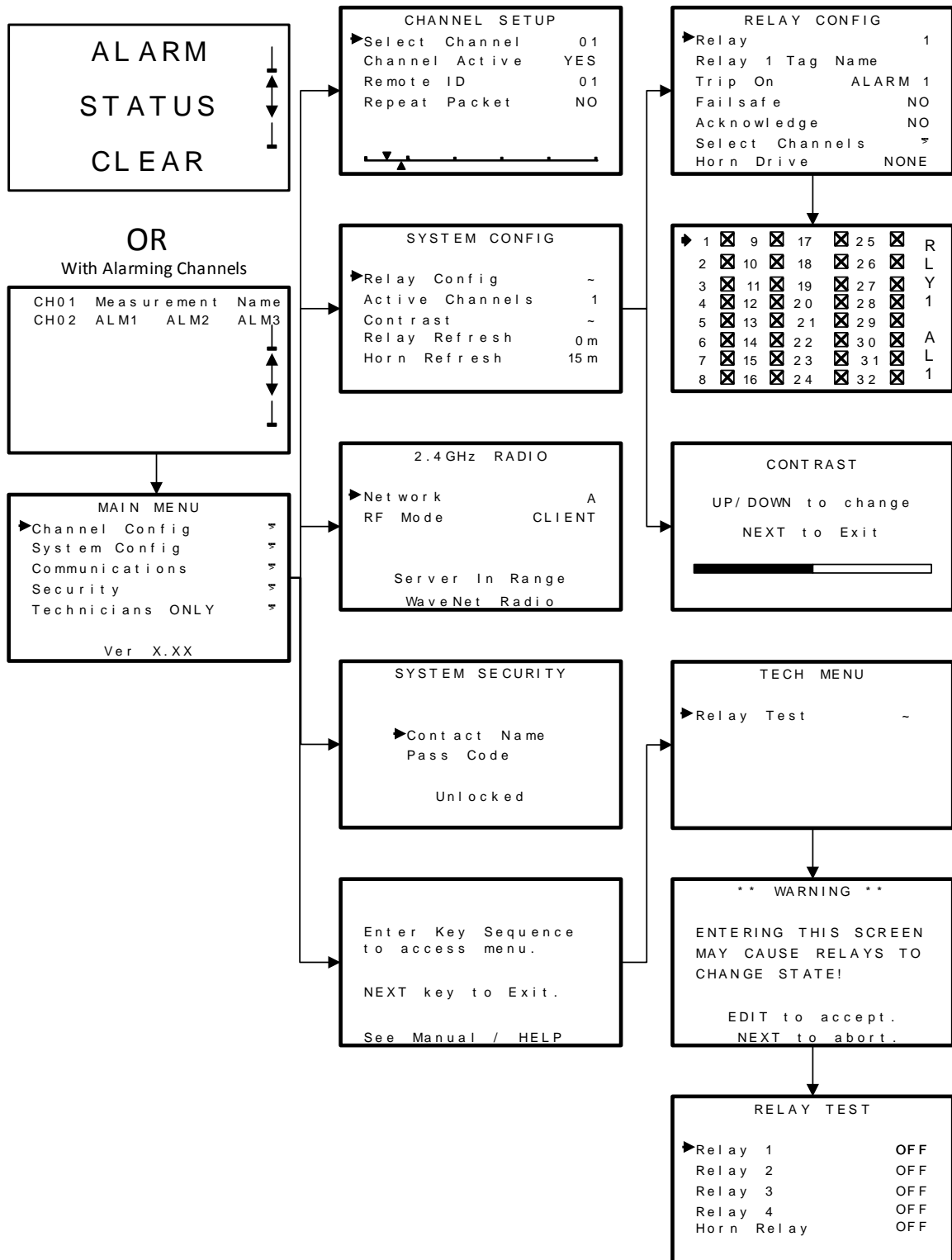

Figure 14-2 SENSICAST Relay Menu Tree

14.2.1 MAIN MENU

The MAIN MENU group shown in Figure 14-3 below is reached by swiping the EDIT key while on the Home Screen. This is the entry-level screen to Channel Config, System Config, Communications, Security and Technicians ONLY menus, and displays the current firmware version. Use the UP/DOWN keys to move the pointer to the desired menu and swipe the EDIT key.

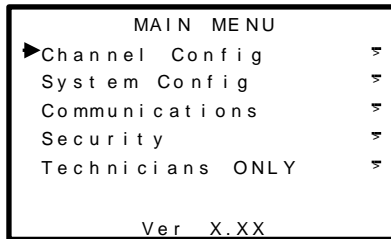

Figure 14-3 Main Menu

14.2.2 CHANNEL CONFIG MENU GROUP

The CHANNEL CONFIG menu shown in Figure 14-4 allows configuration of variables specific to the selected channel. The channel to be affected is selected by swiping the EDIT key. If the selected channel is in an alarm state the Comm Error Timeline will be replaced by an indication of the type of alarm being received.

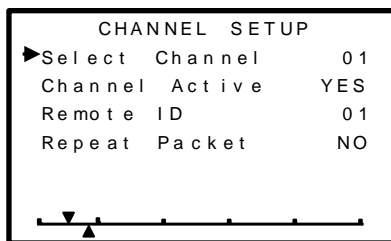

Figure 14-4 SENSACAST RELAYER Channel Config Menu

14.2.2.1 CHANNEL ACTIVE

Channel Active is a YES/NO field that allows temporarily deactivating channels. Channels that may be deactivated are limited to the number of **Total Channels** designated in the System Config menu group (see [Section 14.2.3.2](#)). If a channel is to be permanently removed then **Total Channels** should be adjusted down to reflect the number of SENSACAST TRANSMITTERs communicating to this SENSACAST RELAYER.

14.2.2.2 REMOTE ID

The **Remote ID** menu determines which SENSACAST TRANSMITTER RTU number is assigned to this SENSACAST RELAYER channel. RTU numbers are limited to 1-32, but any of these may be assigned to any of the 32 SENSACAST RELAYER channels. This is useful for arranging which SENSACAST RELAYER channels are used to relay specific SENSACAST TRANSMITTER information. For example, dual gas SENSACAST TRANSMITTERs have consecutive RTU numbers. It might be desirable to separate these at the SENSACAST RELAYER in order to keep same gas types together.

14.2.2.3 REPEAT PACKET

By turning the Repeat Packet option on, any received packet by the SENSACAST RELAYER will automatically be re-transmitted on the current hopping frequency. This is useful to ensure that distant SENSACAST TRANSMITTER transmissions will reach all of the SENSACAST CONTROLLER and SENSACAST RELAYER receivers.

14.2.2.4 COMM ERROR TIMELINE

The horizontal Comm Error Time Line on the bottom of this screen is divided into five segments, from left to right. Each segment equals one SENSCAST TRANSMITTER Wakeup Timer interval from the SENSCAST TRANSMITTER providing data to this SENSCAST RELAYER channel (see [Section 8.1.3](#)). Therefore, the entire time line is equal to 5 times the Wakeup Timer value.

The arrow on the top side of the Time Line slides across the line as time goes by for the current channel being observed. However, every time the SENSCAST TRANSMITTER broadcast packet is received on this channel, the pointer resets to the left of the time line. If the pointer reaches the right of the time line the SENSCAST CONTROLLER will raise a comm error for this channel. For example, if the Wakeup Timer is set for the maximum 5 minutes it requires 25 minutes without a broadcast to raise the Comm Error alarm for the channel. If the wireless link between the SENSCAST TRANSMITTER and this channel is functioning properly the pointer should never exceed the 1st Wakeup Timer line segment.

The arrow on the bottom side of the Time Line slides across the line as time goes by in a similar manner to the other arrow. However, this arrow represents the channel which is furthest along it's time line for all of the monitored channels. This is useful in determining if any channels have missed a transmission without having to cycle through observing all of the channels. If the arrow on the bottom side has not passed the first segment, all of the monitored channels have received their latest transmission.

14.2.3 SYSTEM CONFIG MENU GROUP

The **SYSTEM CONFIG** menus shown in Figure 14-5 allows configuration of variables for the SENSCAST RELAYER unrelated to any specific channel. This includes editing how the relays function, total number of channels, contrast and relay refresh time.

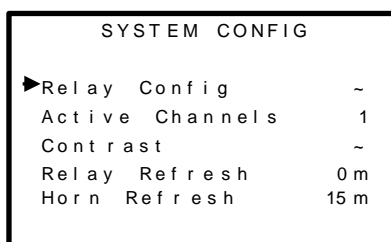

Figure 14-5 SENSCAST RELAYER System Config Menu

14.2.3.1 RELAY CONFIG

The **RELAY CONFIG** screen shown in Figure 14-6 allows sophisticated programming of each of the four programmable relays. Select the relay to be configured by pointing to the Relay menu and swiping **EDIT**.

Note: The fifth relay, the dedicated Horn Relay, is enabled by the Horn Drive setting for each of the four programmable relays.

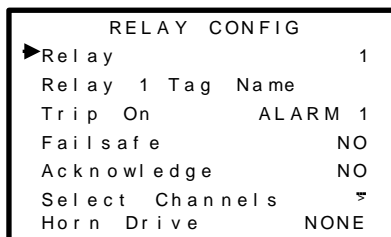

Figure 14-6 Configure Relays Menu

- **Tag Name** may be edited to give the selected relay a name, which will help identify which SENSICAST TRANSMITTERs are connected to that relay or the type of alarm associated with that relay or any name of the user's choosing.
- **Trip On** controls what conditions will cause the relay to activate. These may be **A1, A2, A3, FAULT/COMM** or **Any Alarm** (from a SENSICAST TRANSMITTER).
- **Failsafe** is an ON/OFF field where ON causes the relay to energize when the condition is not present. When the **Trip On** condition becomes true the relay de-energizes. **Failsafe** is often utilized when it is desirable for loss of power to indicate the alarm condition.
- **Acknowledge** is an ON/OFF field with ON typically used when the relay controls an audible device and it is desirable to silence the horn audible while troubleshooting the alarm. Applying an Alarm Reset causes the relay to return to its inactive state even though the alarm condition remains in effect. The **Relay Refresh** menu (see [Section 14.2.3.4](#)) may be used to re-activate acknowledged relays.
- **Select Channels** brings up a Check Box (Figure 14-7) screen for assigning which of the Active Channels are assigned to this relay. This allows creating Zones among the active channels.

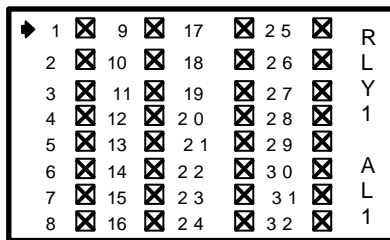

Figure 14-7 Select Channels Menu

- **Horn Drive** controls the operation of the horn drive in relation to any of the four programmable relays. **Horn Drive** selects how the horn drive will function for the relay selected. Select one of three options:
 - **None – no horn**
 - **Pulse**
 - **Steady**

Note: Steady overrides the pulse condition.

When the alarm condition is present for the selected relay the relay will energize along with the horn drive in the manner selected.

14.2.3.2 ACTIVE CHANNELS

Active Channels may be set from 1 to 32 and limits the maximum number of active channels. For example, if this menu is set for 10, then only 10 channels are available in the CHANNEL CONFIG menus discussed in [Section 14.2.2](#).

14.2.3.3 CONTRAST

LCD Contrast Adj. may be set for optimum viewing using the menu shown in Figure 14-8. Swipe the UP/DOWN keys to adjust the contrast and NEXT to save the changes.

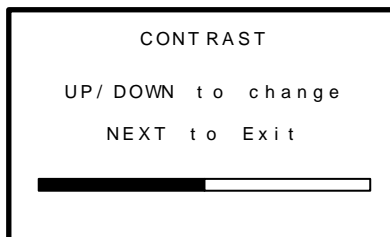

Figure 14-8 LCD Contrast Adjust

14.2.3.4 RELAY REFRESH

Relay Refresh may be set from 0 to 120 minutes with 0 turning the Refresh function OFF. Each relay may be set to allow **Acknowledge** (see [Section 14.2.3.1](#)) which means an **Alarm Reset** deactivates the relay even though the alarm condition still exists. **Refresh** will re-activate the relay after this timer expires. This feature is useful for silencing audible devices, and then automatically activating them again if the alarm condition remains after a period of time.

14.2.3.5 HORN REFRESH

Horn Refresh may be set from 0 to 120 minutes with 0 turning the Refresh function OFF. The horn relay may be set to allow **Acknowledge** (see [Section 14.2.3.1](#)) which means an **Alarm Reset** deactivates the relay even though the alarm condition still exists. **Refresh** will re-activate the relay after this timer expires. This feature is useful for silencing audible devices, and then automatically activating them again if the alarm condition remains after a period of time.

14.2.4 COMMUNICATIONS

The **Communications Menu** shown below in Figure 14-9 allow setting the *Network ID* and *RF Mode*.

For 900MHz models the power level option is also available from this screen.

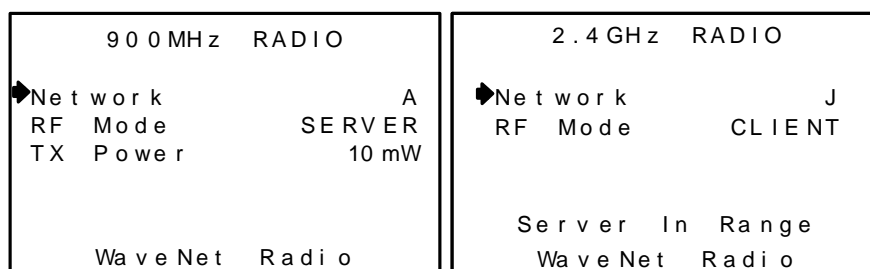

Figure 14-9 Communications Menu

14.2.4.1 NETWORK

SensCast devices utilize the **Network** setting to assign up to 26 unique hopping patterns. To simplify system setup, **Network** is entered using letter designators A through Z where A = [Hop Channel 1, System ID 1] and Z = [Hop Channel 26, System ID 26]. A SENSICAST RELAYER will not indicate Server In-Range status or communicate with any device operating on a different **Network ID**. This feature allows multiple SensCast wireless systems to be located within range of each other without interference.

Networks M through Z are encrypted networks. When one of these networks is selected, the data will be encrypted via proprietary methods to ensure that only devices on that network which hold the encryption key will be able to decipher the data being transmitted.

2.4GHZ used in EU countries: Hop channels on 2.4 GHZ models may be set between 1 and 26. Hop channels A-R include EU “low band” frequencies 2406 – 2435MHZ. Hop channels S-Z include EU “high band” frequencies 2444 – 2483.5MHZ.

IMPORTANT!! EXPLORE WHAT FREQUENCIES ARE APPROPRIATE FOR THE FINAL LOCATION OF ANY WIRELESS SYSTEM.

14.2.4.2 RF MODE

RF Mode determines if the SENSICAST RELAYER is a Server or a Client. **ONLY ONE SERVER IS ALLOWED PER WIRELESS NETWORK.** Numerous SENSICAST RELAYERs may share the same Network, but only one may be the

Server. Networks with multiple SENSICAST RELAYERs should have the most centrally located unit designated as the Server (see [Section 2.2](#)).

14.2.4.3 TX POWER

The **TX Power** menu is only available on 900MHz systems, and allows the setting of the **TX Power** for the radio. The settings for this are 10mW, 200mW, 400mW and 1W.

14.2.5 SECURITY

The **SECURITY** menu in Figure 14-10 requires the 4-digit **Pass Code** prior to altering menus. Entering a Pass Code and locking the menu locks the entire menu database until the correct **Pass Code** is entered. **Contact Name** is a 12 character ASCII field available for displaying a phone # or name of personal who know the **Pass Code**. Lost **Pass Codes** may be recovered by entering the locked security menu and holding the UP key for 5 seconds. The 4-digit code appears near the bottom of the screen.

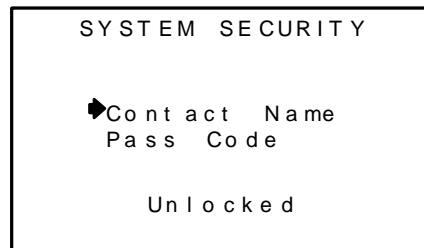

Figure 14-10 Security Menu

14.2.6 TECHNICIANS ONLY

WARNING! Users of these menus must have a detailed understanding of their functions. Processing of alarms and wireless communications should not be relied upon while editing these menus.

The **TECHNICIAN ONLY** menu group access requires a special key sequence of four consecutive **UP** keystrokes to prevent accidental modification of critical items. The **TECHNICIANS ONLY** menu tree is shown in Figure 14-11.

The **TECHNICIAN ONLY** menu group contains a **Relay Test** function which allows the user to stimulate the five relay outputs to ensure proper operation. Use the UP/DOWN keys to highlight the desired relay and select using **EDIT** to energize the relay.

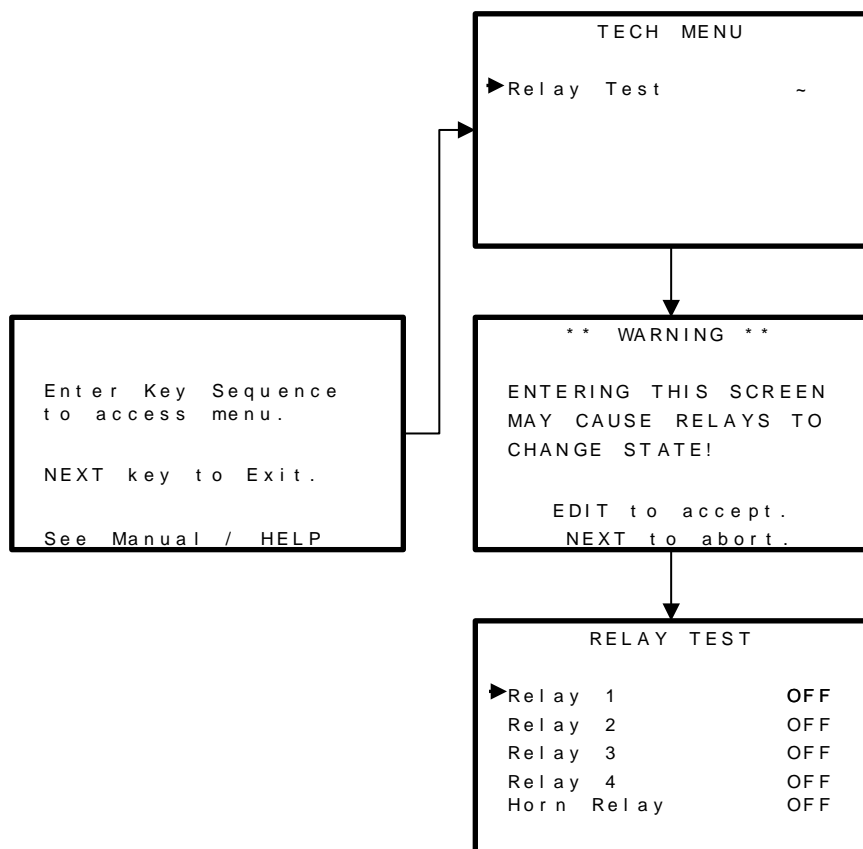

Figure 14-11 TECHNICIANS ONLY Menu Tree

14.3 SENSCAST RELAYER PCBs

14.3.1 SENSCAST RELAYER 299-0083-01 DISPLAY / RADIO PCB

SensCast systems support both 900MHz and 2.4GHz FHSS networks determined by the radio module mounted to the 299-0083-01 Display / Radio PCB. The 299-0041-01 900 MHz radio module mounts to the back of the 299-0083-01 Display assembly as shown in Figure 14-12. Its MMCX RF connector attaches to the coax pigtail of the 299-0079-01 antenna fitting required for 900 MHz models.

The 299-0051-01 2.4GHz radio module also mounts to the back of the 299-0083-01 Display assembly as shown in Figure 14-12. Its uFL RF connector attaches to the coax pigtail of the 299-0080-01 antenna fitting required for 2.4 GHz models.

A slender 5 conductor cable connects between the 299-0083-01 and the 10-0324 Power Supply/Relay PCB bolted to the bottom of the enclosure.

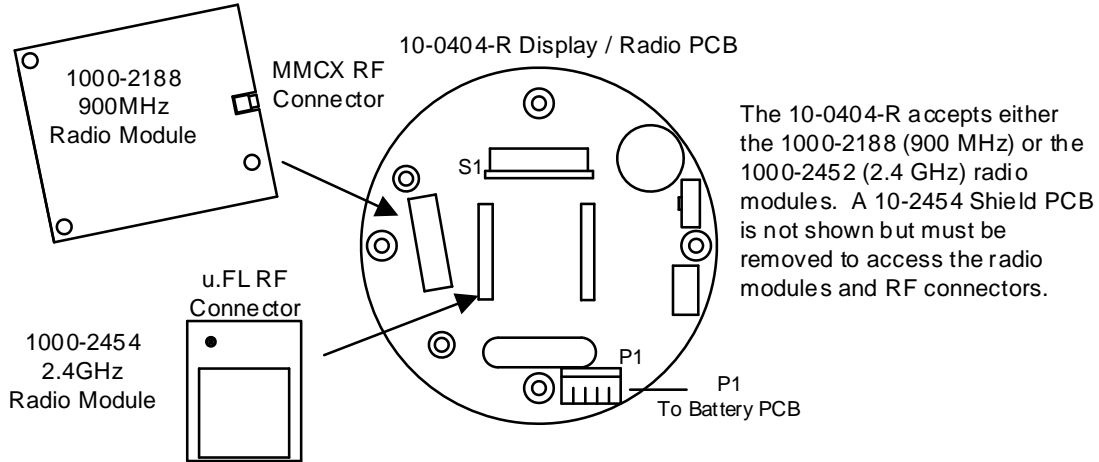

Figure 14-12 299-0083-01 Display / Radio PCB

14.3.2 SENSICAST RELAYER 299-0092-01 POWER SUPPLY/RELAY PCB

CAUTION: Alarm relays have dry contacts and power must be supplied from an external source. If this power source exceeds 3 amps users should consider fusing relay wiring with 3 amp fuses. Contacts are rated for **RESISTIVE** loads! Inductive loads, such as contactor coils or motors, may cause contact arcing, which shortens life and emits RFI into the sensor signals. Use appropriate arcing snubbers and MOV's across inductive loads and keep wiring away from signal wires. External wiring to TB3 (Remote Alarm Reset) should be shielded and protected from noise spikes to prevent false Alarm Reset.

Relay terminals are labeled NO (normally open), NC (normally closed) and COM (common). These designators correspond to the shelf, or de-energized, state of the relays.

AC or DC power supplies to relays on the 299-0092-01 Power Supply/Relay PCB must be the same for each relay. Example: 24VDC should not be the power switched by one relay and 115VAC by others.

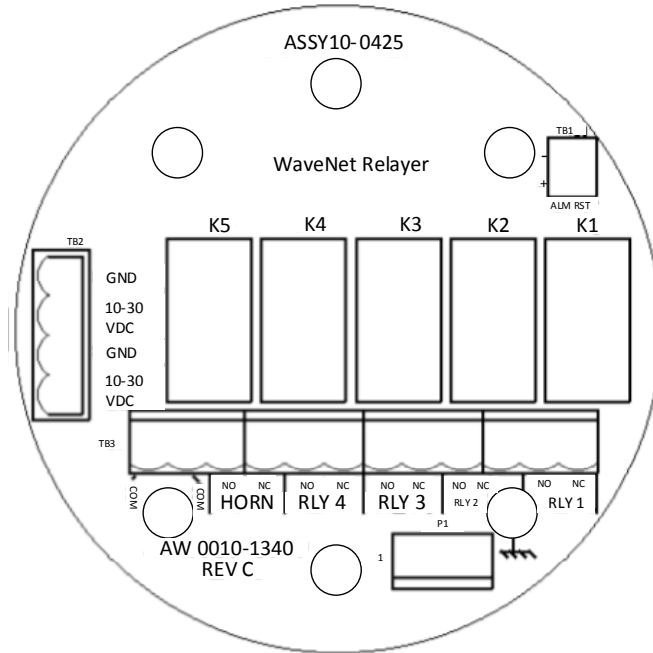

Figure 14-13 299-0092-01 Power Supply/Relay PCB

Chapter 15 – SENSCAST RELAYER INSTALLATION INSTRUCTIONS

15.1 RATINGS AND CERTIFICATIONS

The enclosure is NRTL certified for Division 1 hazardous area installations for explosion-proof Class 1 Groups A, B, C, D (see Figure 4-1). The SensCast Relayer is designed to meet ISA 92.0.01 Part 1 for Toxic Monitors. The standard 10-0295 antenna fitting has an RP-TNC connector and is suitable for Division 2 classified areas. An optional explosion-proof dipole antenna is also available for Division 1 classified areas. Figure 4-2 shows both antenna styles.

15.2 MOUNTING THE ENCLOSURE

The SENSCAST RELAYER standard enclosure is a cast aluminum explosion-proof (NEMA 7) enclosure as shown in Figure 15-1. Modular design simplifies the installation of the SENSCAST RELAYER. The SENSCAST RELAYER antenna should typically be mounted with “line of sight” access to the SensCast Monitor’s antenna. If a good “line of sight” angle is not possible the SENSCAST RELAYERS will usually still function properly at ranges up to 1500 feet but obstructions should be kept to a minimum.

WARNING: Qualified personnel should perform the installation according to applicable electrical codes, regulations and safety standards. Ensure correct cabling and sealing fitting practices are implemented. Install the SENSCAST RELAYER to a wall or bracket using the pre-drilled mounting flanges with I.D. 0.3 on 5.0 inch centers (Figure 15-1).

15.2.1 SENSCAST TRANSMITTER 299-0072-01 MAGNETIC MOUNT OPTION

Sensidyne, LP offers a magnetic mounting option (299-0072-01) which includes two magnets affixed to the pre-drilled mounting holes securely attaching the assembly to a solid steel structure.

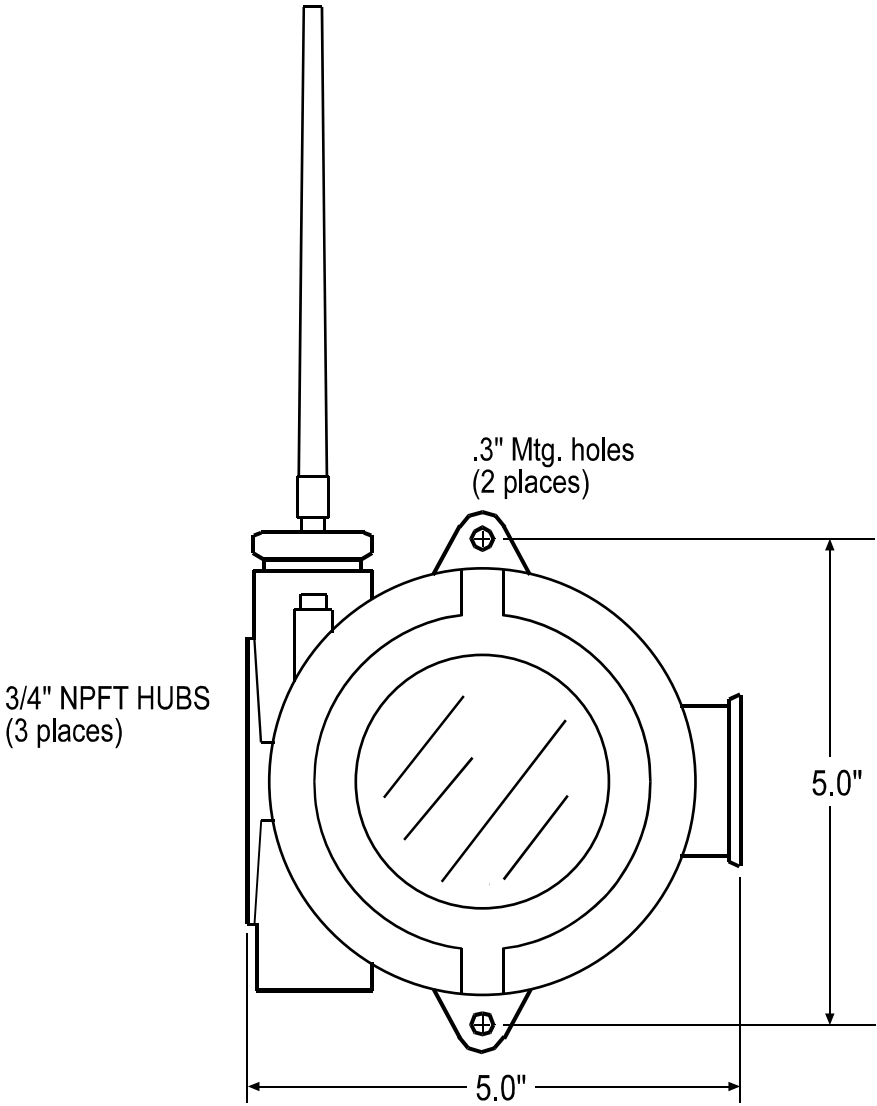

Figure 15-1 SENSICAST RELAYER Explosion-Proof Housing

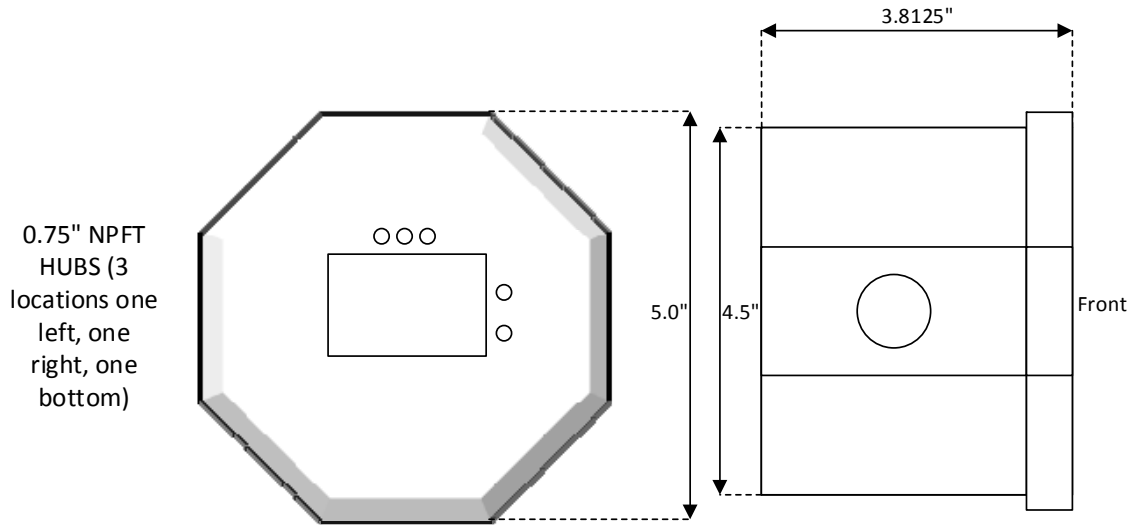

Figure 15-2 SENSICAST RELAYER Polycarbonate Enclosure

15.3 SPECIFICATIONS

15.3.1 POWER SUPPLY

10-30 VDC @ 3 watts max.

15.3.2 POWER CONSUMPTION

900MHz Models:

2mA during “sleep” mode, 40mA while receiving beacon, up to 1 amp during 1 watt “transmit” mode. Transmit power may be set from 10mW to 1 watt.

2.4GHz Models:

2mA during “sleep” mode, 170mA during 125mW Broadcasts.

15.3.3 MAXIMUM TRANSMIT (TX) POWER

900MHz Models (EIRP; 2dBi gain antenna):

Maximum transmit power is 30dBm at highest 1W power setting. Transmit power may be set from 10mW, 100mW, 400mW and 1 watt.

2.4GHz Models (Conducted; no antenna):

Transmit power is fixed at 125mW (21dBm)

15.3.4 RECEIVE (RX) SENSITIVITY

900MHz Models:

-100 dBm

2.4GHz Models:

-95 dBm

15.3.5 RADIO FREQUENCY

900MHz Models:

Hopping occurs between 902 – 928 MHz.

2.4GHz Models:

Hopping occurs between 2400 – 2483.5 MHz.

15.3.6 MEMORY

Non-volatile E2 memory retains configuration values in the event of power outages.

15.4 ANTENNA TRANSMISSION RANGE

The distance radio signals can travel is dependent upon several factors including antenna design, transmitter power and Free-space losses. In order for a wireless link to work, the available system operating margin (**TX power - RX Sensitivity + Antenna gains**) must exceed the Free-space loss and all other losses in the system. For best RF line-of-site, the combined height of both antennas must exceed the Fresnel zone diameter.

<u>Dist. between ant's</u>	<u>Fresnel zone diameter</u>	<u>Freespace loss (dB)</u>
1000 ft (300 m)	16 ft (4.9 m)	81
1 Mile (1.6 km)	32 ft (9.7 m)	96
5 miles (8 km)	68 ft (20.7 m)	110

Example:

A 2.4GHz SensCast system has following parameters:

- RF TX power setting = 21 dBm (125 mW)
- RF RX sensitivity = -95 dBm (this is a constant)
- Antenna gain (standard equipped rubber collinear) = 7dBi x 2 = 14dBi

So the system operating margin is $21 - (-95) + 14 = 130$ dBm. This is enough to transmit 5 miles if Free-space was the only loss in the system. For this to be the case, the antennas must be mounted with a combined height greater than 68ft above all obstructions (including the ground) to keep the Fresnel zone clear. In practice however, there are many losses in the system besides just Free-space and it is recommended there be at least 20dB extra system operating margin.

RF “Rules of Thumb”:

- Doubling the range with good RF “Line of Sight” (LOS) requires an increase of 6 dB.
- Doubling the range without good RF LOS requires an increase of 12 dB.
- Doubling the power increases dBm by 3.

15.4.1 ANTENNA SELECTION AND LOCATION

Refer to [Section 4.5.1](#) for antenna selection and location instructions.

15.4.2 WATER PROOFING ANTENNA CONNECTIONS

Refer to [Section 4.5.2](#) for instructions on water proofing antenna connections.

15.4.3 SYSTEM GROUNDING

Refer to [Section 4.5.3](#) for instructions on System Grounding.

Chapter 16 – SENSCAST ANTENNA SELECTION

16.1 ANTENNA SELECTION

16.1.1 DIPOLE AND COLLINEAR ANTENNAS

These antennas are connected to the Radio via a length of coax cable. If the cable is larger than 6mm diameter (1/4 inch), be aware of sideways tension on the connection. Thick cables have large bending radii and sideways force on the connector can cause a poor connection.

The polarity of these antennas is the same as the main axis, and they are normally installed vertically. They can be mounted horizontally (horizontal polarity), however the antenna at the other end of the wireless link would need to be mounted perfectly parallel for optimum performance. This is very difficult to achieve over distance. If the antenna is mounted vertically, it is only necessary to mount the other antennas vertically for optimum “coupling” – this is easy to achieve.

Dipole and collinear antennas provide best performance when installed with at least 1 to 2 wavelengths clearance of walls or steelwork. The wavelength is based on the frequency:

Wavelength in meters = $300 / \text{frequency in MHz}$

Wavelength in feet = $1000 / \text{frequency in MHz}$

Therefore, 900 MHz antennas require at least 2/3 meter (2 feet) and 2.4GHz 15 cm (6 inches). Antennas may be mounted with less clearance but radiation will be reduced. If the radio path is short this won't matter. It is important the antenna mounting bracket to well connected to “earth” or “ground” for good lightning surge protection.

16.1.2 YAGI ANTENNAS

Yagi antennas are directional along the central beam of the antenna. The folded element is towards the back and the antenna should be pointed in the direction of the transmission. Yagis should also be mounted with at least 1 to 2 wavelengths of clearance from other objects. The polarity of the antenna is the same as the direction of the orthogonal elements. For example, if the elements are vertical the Yagi transmits with vertical polarity.

In networks spread over wide areas, it is common for a central unit to have an omni-directional antenna and the remote units to have Yagi antennas. In this case, as the omni-directional antenna will be mounted with vertical polarity, then the Yagi's must also have vertical polarity. Care needs to be taken to ensure the Yagi is aligned correctly to achieve optimum performance.

Two Yagis can be used for a point-to-point link. In this case they can be mounted with the elements horizontally to give horizontal polarity. There is a large degree of RF isolation between horizontal and vertical polarity (approx – 30dB) so this installation method is a good idea if there is a large amount of interference from another system close by transmitting vertical polarity.

An important mounting tip – if a Yagi has drainage holes in the dipole element, do not mount the antenna with the drainage.

16.1.3 MOUNTING NEAR OTHER ANTENNAS

Avoid mounting your network's antenna near any other antenna even when the other antenna is transmitting on a different radio band. High RF energy of the transmission from a close antenna can deafen a receiver. This is a common cause of problems with wireless systems.

Because antennas are designed to transmit parallel to the ground rather than up or down, vertical separation between antennas is a lot more effective than horizontal separation. If mounting near another antenna cannot be avoided, mounting it beneath or above the other antenna is better than mounting beside it. Using different polarity to the other antenna (if possible) will also help to isolate the RF coupling.

16.1.4 COAX CABLES

If a coax cable connects to the antenna via connectors, it is very important to weatherproof the connection using our 1000-2314 or equivalent sealing tape. Moisture ingress into a coax cable connection is the most common cause of problems with antenna installations. A three layer sealing process is recommended – an initial layer of electrical PVC tape, followed by a second layer of self-vulcanizing weatherproofing tape (1000-2314), with a final layer of electrical PVC tape (see [Section 4.5.2](#)).

Allowing a drip "U loop" of cable before the connection is also a good idea. The loop allows water to drip off the bottom of the U instead of into the connection, reduces installation strain and provides spare cable length in case later the original connectors need to be removed, the cable can be cut back and new connectors fitted.

Avoid installing coax cables together in long parallel paths. Leakage from one cable to another has a similar effect as mounting an antenna near another antenna.

16.2 SURGE PROTECTION & GROUNDING

Voltage surges can enter the SensCast System via the antenna connections, power supply connections, connections to other equipment and even the earth or ground connection. Surges are electrical energy following a path to earth and the best protection is achieved by draining the surge energy to earth via an alternate path. Wireless devices need to have a solid connection to earth via a ground stake or ground grid if the soil has poor conductivity. Solid connection means a large capacity conductor (not a small wire) with no coils or sharp bends. All other devices connected to the SENSICAST CONTROLLER need to be grounded to the same ground point. There can be significant resistance between different ground points leading to very large voltage differences during lightning activity. As many wireless units are damaged by earth potential surges due to incorrect grounding as direct surge voltage.

It is very difficult to protect against direct lightning strikes but the probability of a direct strike at any one location is very small. Unfortunately, power line surges and electromagnetic energy in the air can induce high voltage surges from lightning activity several miles away.

16.2.1 ANTENNA GROUNDING

Electromagnetic energy in the air will be drained to ground via any and every earth path. An earth path exists between the antenna and the SensCast, and to protect against damage this earth path current must be kept as small as possible. This is achieved by providing better alternate earth paths. It is important to ground the antenna to the same ground point as the SensCast. Antennas are normally mounted to a metal bracket which should be grounded to the SensCast earth connection. Surge energy induced into the antenna will be drained first by the mount's ground connection, second by the outside shield of the coax cable to the ground connection on the radio and third by the internal conductor of the coax cable via the radio electronics. This third earth path causes

damage unless the other two paths provide a better earth connection allowing surge energy to bypass the electronics.

When an antenna is located outside of a building and outside of an industrial plant environment, external coax surge diverters are recommended to further minimize the effect of surge current in the inner conductor of the coax cable.

Coax surge diverters have gas-discharge element which breaks down in the presence of high surge voltage, and diverts any current directly to a ground connection. A surge diverter is not normally required when the antenna is within a plant or factory environment, as the plant steelwork provides multiple parallel ground paths and good earth grounding will provide adequate protection without a surge diverter.

16.2.2 CONNECTIONS TO OTHER EQUIPMENT

Surges can enter the wireless unit from connected devices, via I/O, serial or Ethernet connections. Other data devices connected to the wireless unit should be well grounded to the same ground point as the wireless unit.

Special care needs to be taken where the connected data device is remote from the wireless unit requiring a long data cable. As the data device and the wireless unit cannot be connected to the same ground point, different earth potentials can exist during surge conditions.

There is also the possibility of surge voltages being induced on long lengths of wire from nearby power cables. Surge diverters can be fitted to the data cable to protect against surges entering the wireless unit.

The same principle applies to I/O device is not close to the wireless unit, the risk of surge increases. Surge diverters for I/O wiring are available to protect the wireless unit.

Chapter 17 - SENSCAST LEGACY MODE

SensCast Receivers are not compatible with SENSCAST TRANSMITTERs in legacy mode.

When using a SensCast Monitor with other Sensidyne, LP controllers, such as the ST-72, ST-90, ST-71, Rig Protector or other legacy type controllers, it is necessary to operate wirelessly in Legacy Mode.

To enter Legacy mode enter the **RF Link Menu** discussed in [Section 8.1.8](#). To switch from SensCast mode to Legacy mode select RF Link and enter the special key sequence of four **UP** keystrokes. Once in Legacy mode it is necessary to enter the appropriate **Hop Channel** and **System ID** in accordance with your **Server's Network Configuration**. All other SENSCAST TRANSMITTER settings function as discussed in [Section 8.1](#).

Chapter 18 - TABLE OF FIGURES

Figure 3-1 Readout Screen.....	5
Figure 3-2 299-0084-01 Battery / I/O PCB.....	6
Figure 3-3 299-0082-01 Display / Radio PCB.....	7
Figure 4-1 SENSCAST TRANSMITTER NEMA 7 Explosion-Proof Enclosure	9
Figure 4-2 SENSCAST TRANSMITTER Polycarbonate Enclosure	10
Figure 4-3 Local Antennas.....	12
Figure 4-4 Water Proofing Antenna Connections	13
Figure 5-1 1000-0078 Magnetic Wand	14
Figure 5-2 Calibration Gas Input.....	15
Figure 5-3 Cal-Mode Flow Chart and Menus.....	16
Figure 5-4 Replace Battery Screen.....	16
Figure 5-5 Smart Sensor Info / ERROR Screens	17
Figure 5-6 Sensor Separation Kit 299-0091-01	17
Figure 5-7 299-0069-01 Smart Sensor Head Assembly.....	18
Figure 6-1 Main Menu Entry.....	19
Figure 6-2 SensCast Transmitter Monitor Channel Configuration Menu Tree	20
Figure 7-1 Channel Setup Menus	21
Figure 7-2 Configure Readout Setup Menus	21
Figure 7-3 Alarm Settings Menus	23
Figure 7-4 Smart Sensor Information Screen	24
Figure 7-5 Technicians Menu Tree	25
Figure 7-6 RF Link Test	26
Figure 7-7 Temperature Compensation Table.....	27
Figure 8-1 Device Setup Menus	28
Figure 8-2 RF Link Setup Menu	28
Figure 8-3 Clock & Calendar / Delay Timer Menu	31
Figure 8-4 System Security Menu.....	32
Figure 8-5 LCD Contrast Adjust Menu.....	32
Figure 8-6 Turn Power OFF Menu.....	32
Figure 9-1 SENSCAST CONTROLLER Front Panel.....	35
Figure 9-2 299-0066-01 SENSCAST CONTROLLER Display PCB.....	35
Figure 9-3 SENSCAST CONTROLLER Data Displays	36
Figure 9-4 EUNIT/Bar Graph Screen.....	37
Figure 9-5 Event Log Screen	38
Figure 10-1 SENSCAST CONTROLLER Menu Tree	41

Figure 10-2 SENSCAST CONTROLLER Main Menu.....	42
Figure 10-3 SENSCAST CONTROLLER Channel Config Menu.....	42
Figure 10-4 SENSCAST CONTROLLER System Config Menu.....	43
Figure 10-5 Configure Relays Menu.....	44
Figure 10-6 Select Channels Screen.....	44
Figure 10-7 Piezo Functions.....	44
Figure 10-8 Time/Date Menu.....	45
Figure 10-9 Communication Menus.....	46
Figure 10-10 SENSCAST Radio Menus.....	46
Figure 10-11 RX History.....	47
Figure 10-12 Security Menu.....	47
Figure 10-13 Display Event Log Pages.....	48
Figure 10-14 Flash/USB Drive Menu.....	49
Figure 10-15 Technicians Only Pages.....	49
Figure 11-1 AC/DC Power Schematic.....	50
Figure 11-2 299-0067-01 Motherboard.....	51
Figure 11-3 299-0068-01 Relay Board.....	52
Figure 11-4 299-0044-01 50 Watt Power Supply.....	53
Figure 12-1 SENSCAST CONTROLLER/PY NEMA 4X Polyester Wall Mount Enclosure.....	54
Figure 12-2 SENSCAST CONTROLLER/PCS NEMA 4 Painted Carbon Steel Wall Mount Enclosure.....	55
Figure 12-3 SENSCAST CONTROLLER/SS NEMA 4X Stainless Steel Wall Mount Enclosure.....	56
Figure 12-4 SENSCAST CONTROLLER/XP NEMA 7 Explosion Proof Wall Mount Enclosure.....	57
Figure 13-1 SENSCAST CONTROLLER Multi-Interface Option Board Menus.....	58
Figure 13-2 Modbus Communication Menu.....	59
Figure 13-3 SensCast Controller Receiver Wi-Fi Menu Tree.....	65
Figure 13-4 Webpage Status Screen (No Alarms).....	67
Figure 13-5 Webpage Status Screen (With Alarms).....	67
Figure 13-6 Relay Config Menu.....	68
Figure 13-7 Channel Config Menu.....	69
Figure 13-8 System Config Menu.....	70
Figure 13-9 Data Logging File Structure.....	72
Figure 13-10 SENSCAST CONTROLLER Data Logging Menu Tree.....	72
Figure 13-11 Webpage Data Logging Menu.....	73
Figure 14-1 SENSCAST Relayer Main Screen.....	74
Figure 14-2 SENSCAST Relayer Menu Tree.....	75
Figure 14-3 Main Menu.....	76
Figure 14-4 SENSCAST RELAYER Channel Config Menu.....	76

Figure 14-5 SENSCAST RELAYER System Config Menu	77
Figure 14-6 Configure Relays Menu	77
Figure 14-7 Select Channels Menu	78
Figure 14-8 LCD Contrast Adjust	78
Figure 14-9 Communications Menu	79
Figure 14-10 Security Menu	80
Figure 14-11 TECHNICIANS ONLY Menu Tree	81
Figure 14-12 299-0083-01 Display / Radio PCB	82
Figure 14-13 299-0092-01 Power Supply/Relay PCB	83
Figure 15-1 SENSCAST RELAYER Explosion-Proof Housing	85
Figure 15-2 SENSCAST RELAYER Polycarbonate Enclosure	86

SENSIDYNE[®]

Sensidyne, LP • 1000 112th Circle N, Suite 100
St. Petersburg, Florida 33716 USA

800-451-9444 • +1 727-530-3602 • +1 727-539-0550 [fax]
web: www.sensidyne.com • e-mail: info@sensidyne.com